

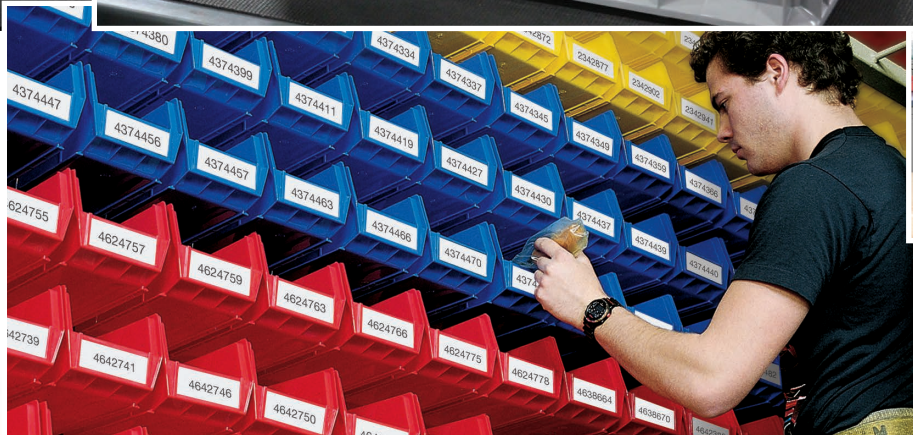

AK-WEST INC

Your Single Source for Reusable Containers and Material Handling Solutions



SERVICE

SELECTION

QUALITY

VOLUME 5

TABLE OF CONTENTS

Storage Bins – Hanging & Stacking.....04-12

04 AkroBins	09 1800 Series AkroBins	12 Stak-N-Store Bins
06 Universal Hanging Bins	09 ESD AkroBins	
08 InSight Bins	10 Super-Size AkroBins	

Labeling13-15

13 Labels & Card Holders	14 Angle•Vu
14 Divider Label Tabs	15 Kanban Extended Label Holder

Storage Bins – Shelf Style.....16-22

16 Shelf Bins	20 Indicator Bins	22 Economy Bins
17 ShelfMax Bins	21 AkroDrawers	
18 ShelfMax8 Bins	22 System Bins	

Heavy-Duty Totes & Containers.....23-32

23 AK HSN Bins	28 Multi-Load Tote	31 Cross-Stack Akro-Tub Racks
24 Nest & Stack Totes (NST)	29 Straight Wall Containers (SWC)	32 Gravity Hopper
26 Akro-Grid	30 Akro-Tub, Cross-Stack Akro-Tub	

Bin Hanging Systems & Racks.....33-43

33 Rail Hanging Systems	37 Low Profile Floor Racks	40 Lean Panel, Lean Floor Rack
34 Louvered Panels	38 Benchtop Spinner Racks	41 Pick Racks
36 Louvered Hooks	38 Louvered Bench Racks	
36 AkroShelf	39 ReadySpace	

Small Parts Storage.....44-45

44 Storage Cases	44 Portable Organizer	45 Roto-Shelf
44 Utility Boxes	45 ProBox Toolboxes	45 Tote Caddy

Cabinets46-57

46 TiltView Bins	50 Plastic Cabinets	54 TiltView Bin Cabinets
48 19 & 17 Series Cabinets	51 Ready-To-Assemble Cabinets	55 Secure Mini-Cabinets
49 Storage-Go-Round	51 Heavy-Duty Bin Cabinets	56 Stackable Cabinets
49 Mobile Rack	52 Standard Bin Cabinets	57 Super Modular Cabinets

Shelving Systems58-70

58 Wire Shelving Components	64 Wire Shelving Systems	67 Steel Shelving Systems
-----------------------------	--------------------------	---------------------------

Dollies71-74

71 Polyethylene Dollies	73 Bin-Specific Steel Dollies
72 Steel Dollies	74 Wood Dollies

Platform Trucks75-83

75 Platform Trucks, Series 5	77 Platform Trucks, Super-Heavy-Duty	82 Platform Trucks, Work Height
76 Platform Trucks, Wood	78 VERSA/Deck	83 Semi-Live Skids
77 Platform Trucks, Steel	80 ULTRA/Deck	

Carts & Work Centers84-91

84 ProCart	89 Box Trucks	90 Mobile Work Tables
85 TiltView Stack Carts	89 Tray Service Carts	91 Heavy-Duty Work Benches
86 Louvered Carts	89 Super-Size AkroBin Carts	
88 Shelf Carts	90 Portable Tables & Carts	

Hand Trucks92-93

92 Heavy-Duty, Medium-Duty, Specialty	93 Dual-Purpose Hand Truck	93 Pail Truck
---------------------------------------	----------------------------	---------------

Bulk Handling94

94 Akro-Tilt Trucks	94 Akro-Carts
---------------------	---------------

Bulk Boxes & Pallets104-107

Scepter Products112-113

Index116-120



Look for this logo throughout our catalog to find the newest, innovative products from Akro-Mils!

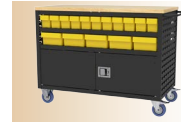

Locking Louvered Cart
See Page 87



Mobile Wire Utility Carts
See Page 63



Cross-Stack Akro-Tub Carts
See Page 31



Single Row Louvered Panel
See Pages 34-35



Mobile Slanted Shelf Starter Units
See Page 63



Bracket to Hang Plastic Cabinets
See Page 50



Stocking/Picking Cart for ShelfMax8™
See Page 19



AkroBins® 2 New Sizes
See Pages 4-5



AK Bins 7 New Sizes
See Page 23





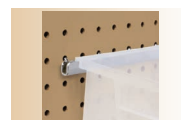

















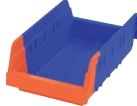
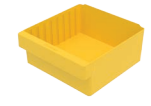















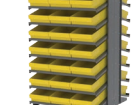





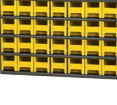









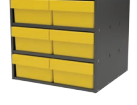























Fire Safety Cabinets
See Page 114



Peg Board Hangers
See Page 5

TABLE OF CONTENTS

								
04 AkroBins	06 Universal Hanging Bins	08 InSight Bins	09 1800 Series AkroBins	09 ESD AkroBins	10 Super-Size AkroBins	12 Stak-N-Store	13 Labels & Card Holders	14 Divider Label Tab : Angle+Vu
								
15 Kanban Extended Label Holder	16 Shelf Bins	17 ShelfMax Bins	18 ShelfMax Bins	20 Indicator Bins	21 AkroDrawers	22 System Bins	22 Economy Bins	23 AK HSN Bins
								
24 Nest & Stack Totes	26 Akro-Grids	28 Multi-Load Totes	29 Straight Wall Containers	30 Akro-Tubs : Cross-Stack Akro-Tubs	32 Easy Flow Gravity Hopper	33 Rail Hanging Systems	34 Louvered Panels : Louvered Racks	36 Louvered Hooks : AkroShelf
								
37 Low Profile Floor Racks	38 Louvered Bench Racks	39 ReadySpace Systems	40 Lean Panels : Lean Floor Rack	41 Pick Racks	44 Storage Cases	44 Portable Organizers	45 Toolboxes	45 Roto Shelf
								
45 Tote Caddy	46 TiltView Bins	48 19 & 17 Series Cabinets	49 Storage-Go-Round	49 Mobile Rack	50 Plastic Cabinets	51 Ready-to-Assemble Cabinet	51 Heavy-Duty Bin Cabinets	52 Standard Cabinets - Solid Door
								
53 Standard Cabinets - Quick-View Door	54 TiltView Bin Cabinets	55 Secure Mini-Cabinets	56 Stackable Cabinets	57 Super Modular Cabinets	58 Wire Components & Starter Units	63 Mobile Wire Shelving Units	64 Wire Shelving Systems	67 Steel Shelving Systems
								
71 Dollies	75 Platform Truck - Series 5	76 Platform Trucks - Wood	77 Platform Trucks - Steel	78 VERSA/Deck	80 ULTRA/Deck	82 Platform Trucks - Work Height & Skids	84 ProCart	85 TiltView Stack Carts
								
86 Louvered Carts	88 Shelf & Multi-Shelf Carts	88 Box Trucks & Tray Service Carts	89 Super-Size Bin Carts	90 Portable Tables & Carts	90 Mobile Work Tables & Work Benches	92 Hand Trucks & Pail Trucks	94 Tilt Trucks & Carts	100 Storage Bins
								
101 Waste & Recycling	104 Bulk Containers	108 Pallets	109 Straightwall Containers	110 Attached & Detached Lid Containers	112 Fuel Containers	114 Safety Cabinets	115 Trays	116 Index

AkroBins®

INDUSTRY-LEADING HANGING & STACKING BINS



A30240

MADE
IN THE
USA

FEATURES

- 1 Anti-slide stop prevents stacked bins from shifting forward
- 2 Optional dividers allow you to create customizable compartment sizes
- 3 Full-width hanger lip supports bin on hanging system
- 4 Curved-bottom hopper front makes it easy to retrieve small parts
- 5 Reinforced side ribs add strength and prevent spreading when stacked
- 6 Large front label area for easy coding and scanning
- 7 Extra-wide stacking ledge provides stability, saves space and prevents spills

PRODUCT HIGHLIGHTS

- **EFFICIENT** – Control inventories, shorten assembly times, minimize parts handling
- **FUNCTIONAL** – Heavy-duty bins securely stack atop each other, sit on shelving, and hang from Akro-Mils racks, panels, rails and carts
- **DURABLE** – Molded of industrial-grade polymers, AkroBins are resistant to weak acids and alkalis. Water, rust and corrosion-proof
- **VARIETY** – Available in 17 sizes and 7 Standard Colors: Red, Blue, Yellow, Stone, Green, Black and Clear! 2 Specialty Colors: Light Blue and Purple available in 9 sizes; 3 Additional Colors: Hunter Green, Sandstone and Terra Cotta available in 8 sizes
- **GUARANTEED** – AkroBins are guaranteed not to crack or break under normal load conditions as stated in our 1-year limited warranty



A30232

AVAILABLE IN
CLEAR

A30210

A30220

A30232

A30242



A30237

A30224

A30230



A30234

A30239



A30240

A30265



A30235

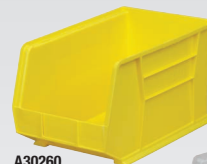

A30260



A30255



A30250



A30270



A30320

STANDARD COLORS

Red, Yellow, Blue, Stone, Green, Clear, Black



SPECIALTY COLORS

Light Blue, Purple





AkroBins	Outside Dimensions (In.)			Bottom Dimensions (In.)				Capacity/Quantity		Accessories							
	Model No.	L	W	H	L	W	H	X	Bin Load Capacity On Rack	Bin Ctn. Qty.	Black Length Dividers‡	Black Width Dividers‡	Clear Length Dividers‡	Divider Pkg. Qty.	Bin Lids	Lid Pkg. Qty.	Adhesive Labels
A30210* [§]	5-3/8	4-1/8	3	4-3/4	3-7/16	2-13/16	4	10 lbs.	24	A40210 (1)	–	A40210CRY	6	A30211CRY	24	A29202	A29301
A30220* [§]	7-3/8	4-1/8	3	6-3/4	3-7/16	2-13/16	6	10 lbs.	24	A40220 (1)	–	A40220CRY	6	A30221CRY	24	A29202	A29301
NEW! A30232	5-3/8	11	3	4-3/4	10-1/8	2-13/16	4	15 lbs.	8	A40210 (3)	–	A40210CRY	6	A30233CRY	8	A29202	A29301
NEW! A30242	7-3/8	11	3	6-3/4	10-1/8	2-13/16	6	15 lbs.	8	A40220 (3)	–	A40220CRY	6	A30243CRY	8	A29202	A29301
A30237	9-1/4	6	5	8-9/16	4-7/8	4-3/4	7-1/4	20 lbs.	12	A40237 (1)	–	A40237CRY	6	–	–	A29203	A29302
A30224*	10-7/8	4-1/8	4	10-1/4	3-3/16	3-3/4	9	20 lbs.	12	A40224 (1)	–	A40224CRY	6	A30225CRY	12	A29202	A29301
A30230*	10-7/8	5-1/2	5	10-1/4	4-3/8	4-3/4	9	30 lbs.	12	A40230 (1)	A41230 (3)	A40230CRY	6	A30231CRY	12	A29203	A29302
A30234*	14-3/4	5-1/2	5	14-1/16	4-3/8	4-3/4	12-13/16	50 lbs.	12	A40234 (1)	–	A40234CRY	6	–	–	A29203	A29302
A30239*	10-3/4	8-1/4	7	10	6-9/16	6-3/4	8	50 lbs.	6	A40239 (1)	–	A40239CRY	6	–	–	A29203	A29302
A30240*	14-3/4	8-1/4	7	14	6-9/16	6-3/4	12	60 lbs.	12	A40245 (1)	–	A40245CRY	6	–	–	A29203	A29302
A30265	18	8-1/4	9	17-1/8	6-3/4	8-1/4	14-1/2	60 lbs.	6	A40265 (1)	–	A40265CRY	6	–	–	A29203	A29303
A30235*	10-7/8	11	5	10-1/4	10	4-3/4	9	50 lbs.	6	A40230 (3)	–	A40230CRY	6	A30236CRY	6	A29203	A29302
A30260	18	11	10	17	9-1/2	9-3/4	14-3/16	60 lbs.	6	A40260 (3)	–	A40260CRY	6	–	–	A29203	A29303
A30255	10-7/8	16-1/2	5	9-3/4	15	4-3/4	9	60 lbs.	6	A40230 (3)	–	A40230CRY	6	–	–	A29203	A29302
A30250*	14-3/4	16-1/2	7	14	14-3/4	6-3/4	12	75 lbs.	6	A40245 (3)	A41250 (3)	A40245CRY	6	–	–	A29203	A29302
A30270	18	16-1/2	11	17-1/8	14-3/4	10-1/4	14	75 lbs.	3	A40270 (3)	A41270 (3)	A40270CRY	6	–	–	A29203	A29303
A30320	8-5/8	33	5	7	31-1/2	4-3/16	6	80 lbs.	4	A40321 & A40220 (7)	–	A40220CRY	7/6	A30321	4	–	–

One color per carton: Specify Red, Blue, Yellow, Stone, Clear, Green or Black. Order in carton quantities. CAUTION: When using bins with hanging systems, do not exceed the weight capacity for the rack, which may be less than the total sum of bin capacities. A40321= Tall Divider; A40220= Short Divider. *Available in Specialty Colors: Purple and Light Blue. †(1) = Max. # of divider slots per bin. A30211CRY replaces A30211; A30221CRY replaces A30221; A30231CRY replaces A30231; A30236CRY replaces A30236.

ACCESSORIES

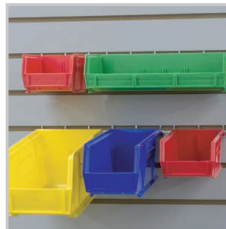

NEW!



Pegboard Bin Adapters

Now hang bins on pegboard or slat wall!
Welded-metal construction provides secure hanging on standard pegboard and slatwall. Two sizes allow for customization of storage space. Large Adapter 10-2/3" Long A30112, Small Adapter 5" Long A30111



Crystal Clear Length Dividers
Fewer shadows make parts easier to find



Length Dividers
Keep items separated in bin. Now available for all sizes!



Width Dividers
Available for A30230, A30250 and A30270



See-Through Crystal Clear Lids
Keep contents dust-free and protected

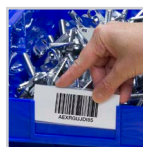

Adhesive Labels & Card Stock Holders
Clearly identify bin contents. (See page 13)



Bin Retainer Clip Model No. A40599
Holds any size AkroBin securely on louvered panels. Perfect for service vans and maintenance workers, plumbers, electricians or other tradespeople who store and transport supplies and materials



Kanban Extended Label Holders
Turn your bin storage system into a complete Kanban system (See page 15)

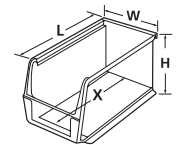
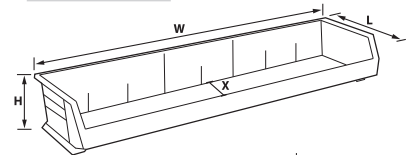

RELATED PRODUCTS

Create the perfect storage system – mix and match your selection of AkroBins with compatible products



33 Rail Hanging Systems



34-39 Louvered Hanging Systems



39 ReadySpace Storage Systems



51-54 Bin Cabinets



58-70 Shelving Systems



84 ProCart

Universal Hanging Bins

VERSATILE, NESTABLE BINS HANG FROM ALL 4 SIDES



FEATURES

- 1 Sloped-side hanging lip lets bin hang at an angle for maximum visibility and part access
- 2 Flat-side hanging lip keeps bin level when hanging
- 3 Rear hanglock allows bin to tilt out on steel or wire shelving units
- 4 Divider slot provides additional storage options
- 5 Integrated lid holes allow for easily attaching optional Crystal Clear Dust Protection Lids; lids attach at either end of the bin
- 6 Bin widths are sized to maximize storage space on standard width steel and wire shelving units

PRODUCT HIGHLIGHTS

- **VERSATILITY** – Moves seamlessly from shelving to louvers to rails, changing from a sloped bin to a regular profile with a 180° turn.
- **NESTABLE** – Universal Bins nest when empty to conserve space
- **VARIETY** – Available in 7 sizes and 4 colors: Red, Blue, Yellow and Clear

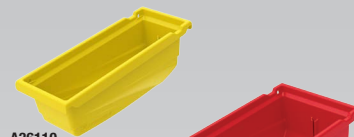

A36110

A36120



A36130



A36140



A36220



A36230



A36240

COLORS

Red, Yellow, Blue, Clear



AVAILABLE IN
CLEAR
CRYSTAL



A36130

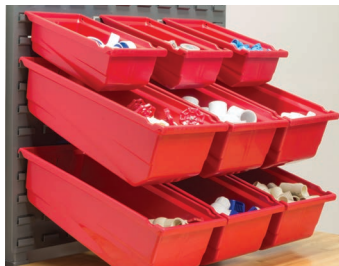

Hanging from the back creates a sloped picking bin without a pick rack, keeping parts visible and accessible



Hanging from the front creates a flat bin profile



Hanging from the side provides space savings in the work area. (Louvered panels only)

Hanging Sloped

Hanging Straight

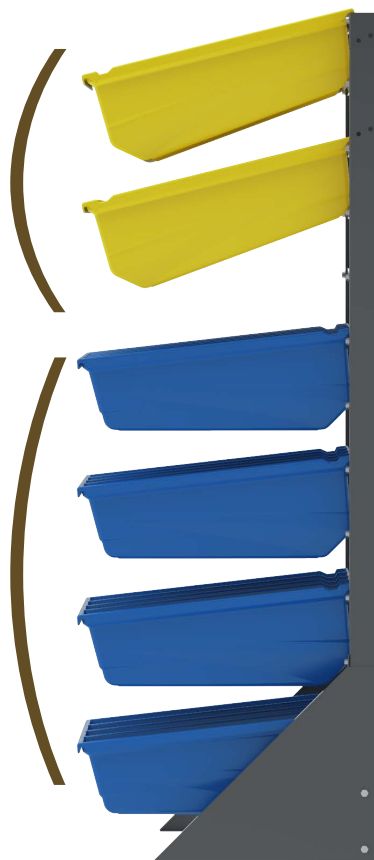

A36230 shown with A30008 Rail Rack

Universal Hanging Bins	Outside Dimensions (In.)			Inside Dimensions (In.)			Quantity	Accessories			
	Model No.	L	W	H	L	W		H	Bin Ctn. Qty.	Dividers	Divider Pkg. Qty.
A36110	11-1/2	4-1/8	4-1/2	9-5/8	2-9/16	4-5/16	16	A46110	12	A36111CRY	8
A36120	11-1/2	6-5/8	4-1/2	9-5/8	5-1/16	4-5/16	10	A46110	12	A36121CRY	10
A36130	11-1/2	8-1/4	4-1/2	9-5/8	6-11/16	4-1/4	8	A46110	12	A36131CRY	8
A36140	11-1/2	11	4-1/2	9-5/8	9-7/16	4-1/4	6	A46110	12	A36141CRY	6
A36220	17-1/2	6-5/8	6-1/2	15-1/4	4-3/4	6-1/4	10	A46220	6	A36221CRY	10
A36230	17-1/2	8-1/4	6-1/2	15-1/4	6-3/8	6-1/4	8	A46220	6	A36231CRY	8
A36240	17-1/2	11	6-1/2	15-1/4	9-1/8	6-1/4	6	A46220	6	A36241CRY	6

One color per carton: Specify Red, Blue, Yellow or Clear. Order in carton quantities. CAUTION: When using bins with hanging systems, do not exceed the weight capacity for the rack.

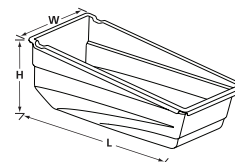

ACCESSORIES



Length Dividers
Available for all sizes



Lids
Attach at either end of the bin



Adhesive Labels
Clearly identify bin contents. (See page 13)

InSight®

ULTRA-CLEAR POLYCARBONATE BINS



MADE IN THE USA



FEATURES

- 1 Unique “lock-in-place” design for secure stacking
- 2 Strong molded hanger supports bins on hanging systems
- 3 Large label area for part identification and bar code scanning
- 4 Optional lids (sold separately) protect contents from dust. Will stack with lids in place!
- 5 Clear length and width dividers available (sold separately)

PRODUCT HIGHLIGHTS

- **VISIBILITY** – Bins provide easy and maximum visibility of parts and supplies
- **FUNCTIONAL** – Bins securely stack, and hang from louvered panels, rails and the ReadySpace® Storage System
- **NO-TIP FEATURE** – Patent-pending design: Bins won't tip when stacked!
- **DURABLE** – Products made of high-impact polycarbonate are autoclavable up to 250° F
- **VARIETY** – Available in 4 sizes

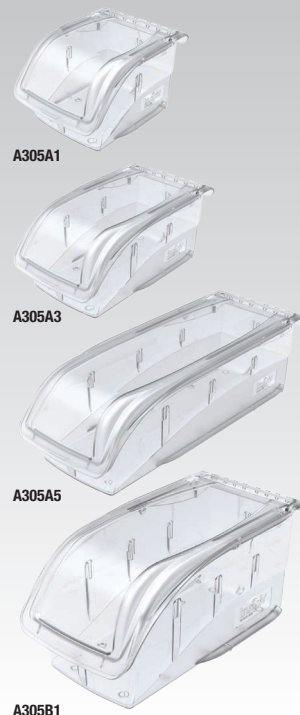

COLOR
Clear



insight
by Akro-Mils

InSight Model No.	Outside Dimensions (In.)			Inside Dimensions (In.)			Capacity/Quantity		Accessories					
	L	W	H	L	W	H	Capacity (lbs.)	Bin Ctn. Qty.	Width Divider*	Divider Pkg Qty.	Length Divider*	Divider Pkg Qty.	Lid	Lid Pkg Qty.
A305A1	5-3/8	4-1/8	3-1/4	4-1/4	3-1/8	2-5/8	10	16	A415A1 (1)	8	A405A1 (1)	8	A305A2	16
A305A3	7-3/8	4-1/8	3-1/4	6-1/4	3-1/8	2-5/8	10	16	A415A1 (2)	8	A405A3 (1)	8	A305A4	16
A305A5	10-7/8	4-1/8	3-1/4	9-1/4	3-1/8	2-5/8	15	12	A415A1 (3)	8	A405A5 (1)	6	A305A6	12
A305B1	10-7/8	5-1/2	5-1/4	9-7/16	4-1/8	4-7/16	25	12	A415B1 (3)	6	A405B1 (1)	6	A305B2	12

*() = Max. # of divider slots per bin.

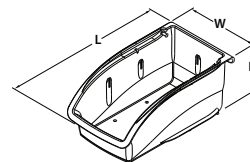

ACCESSORIES



Lids
Protect bin contents from dust



Dividers
Expand sorting options with length dividers

RELATED PRODUCTS

Create the perfect storage solution — mix and match your InSight Bins with these products



33 Rail Hanging Systems



34-39 Louvered Hanging Systems



39 ReadySpace Storage Systems

1800 Series AkroBins® : ESD Containers

SPECIALTY AKROBINS



1800 Series AkroBins®

STACKABLE SHELF BINS

- **DURABLE** – Strong industrial-grade polymer construction
- **STACKING** – Stackable storage systems for large, heavy or bulky items
- **DIVIDABLE** – One black width divider included per bin



A30348

COLOR
Beige



1800 Series	Outside Dimensions (In.)			Inside Dimensions (In.)							
Model No.	L	W	H	L	W	H	X	Ctn. Qty.	Dividers	Pkg. Qty.	Capacity (Lbs.)
A30348BEIGE	20-1/2	8-1/4	7	20	7-3/8	6-1/2	20	6	A40348 (3)	6	60
A30358BEIGE	20-1/2	11	7	20	10-1/8	6-1/2	20	6	A40358 (3)	6	75

Available in Beige. Order in carton quantities.

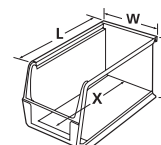

ESD Containers

AKROBINS MADE WITH ELECTROSTATIC DISSIPATIVE MATERIALS

- **PROTECTION** – Dissipate electrostatic charges, which can severely damage sensitive electronic components
- **OHM RATING** – Static Dissipative Range 10^4 to 10^{11} ohms/sq.
- **LOW CARBON** – 1% - 2% carbon content - won't leave residue on parts

COLOR
Black



ESD Containers	Outside Dimensions (In.)			Inside Dimensions (In.)					
Model No.	L	W	H	L	W	H	X	Cap. on Rack	Ctn. Qty.
A30210ESD	5-3/8	4-1/8	3	4-3/4	3-7/16	2-13/16	4	10 lbs.	24
A30220ESD	7-3/8	4-1/8	3	6-3/4	3-7/16	2-13/16	6	10 lbs.	24
A30230ESD	10-7/8	5-1/2	5	10-1/4	4-3/8	4-3/4	9	30 lbs.	12
A30235ESD	10-7/8	11	5	10-1/4	10	4-3/4	9	50 lbs.	6
A30240ESD	14-3/4	8-1/4	7	14	6-9/16	6-3/4	12	60 lbs.	12

Available in Black. Order in carton quantities.

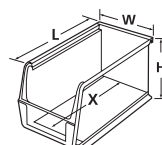

A30235

A30210
A30220

Super-Size AkroBins®

INDUSTRY-LEADING LARGE-CAPACITY STACKING BINS



A30292

MADE
IN THE
USA



5



6

FEATURES

- 1 Reinforced side ribs add strength and prevent spreading when stacked
- 2 Anti-slide stop prevents stacked bins from shifting forward
- 3 Large label area on front of bin
- 4 Divider slots help create separate compartments
- 5 Easy to carry with large handle molded onto back of bin
- 6 **NEW FEATURE** - Optional hinged lid covers and protects while allowing access to contents *even when bins are stacked*

PRODUCT HIGHLIGHTS

- **CAPACITY** – Large-capacity storage to improve organization and workflow
- **STACKABLE** – Heavy-duty bins securely stack atop each other, sit on shelving, carts or dollies; bins can stack with casters attached
- **DURABLE** – Molded of industrial-grade polymers, Super-Size AkroBins are resistant to weak acids and alkalis. Water, rust and corrosion-proof
- **VARIETY** – Available in 12 sizes and 5 colors: Red, Blue, Yellow, Clear, Gray
- **GUARANTEED** – Super-Size AkroBins are guaranteed not to crack or break under normal load conditions as stated in our 1-year limited warranty



A30280

A30281



A30282

A30283

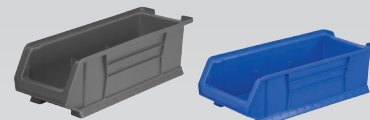

A30284

A30286



A30287

A30288



A30289



A30290



A30292



A30293

COLORS

Red, Yellow, Blue, Clear, Gray



AVAILABLE IN
CLEAR
CLEAR



A30290MOB

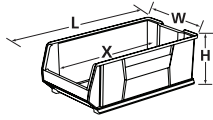

Super-Size AkroBins	Outside Dimensions (In.)			Inside Dimensions (In.)				Capacity/Quantity			Accessories							
	Model No.	L	W	H	L	W	H	X	Max. Cap. per Bin	Stacking Cap./= Qty. Stacked	Ctn. Qty.	Width Dividers*	Length Dividers*	Divider Pkg. Qty. W L	Bin Lids	Lid Pkg. Qty.	Card Stock Holder	
A30280	20	12-3/8	6	16-7/8	10-11/16	5-3/8	15-1/2	200 lbs.	40 lb./10	4	-	A40280 (3)	-	2	A30280L	4	A29304	
A30281	20	12-3/8	8	16-7/8	10-11/16	7-3/8	15-1/2	200 lbs.	50 lb./7	3	-	A40281 (3)	-	3	A30281L	3	A29304	
A30282	20	12-3/8	12	16-7/8	10-11/16	11-3/8	15-1/2	200 lbs.	60 lb./5	2	-	A40282 (3)	-	1	A30282L	2	A29304	
A30283	20	18-3/8	12	16-7/8	16-9/16	11-3/8	15-1/2	300 lbs.	150 lb./5	1	-	A40282 (3)	-	1	A30283L	1	A29304	
A30284	23-7/8	8-1/4	7	20-7/8	6-3/8	6-1/8	19-3/8	200 lbs.	150 lb./5	4	A41284 (2)	A40286 (1)	2	4	-	-	A29304	
A30286	23-7/8	11	7	20-7/8	9-1/8	6-1/8	19-5/16	200 lbs.	150 lb./5	4	A41286 (2)	A40286 (3)	2	4	A30286L	4	A29304	
A30287	23-7/8	11	10	20-3/4	9	9-1/8	19-5/16	300 lbs.	150 lb./5	4	A41287 (2)	A40287 (3)	6	6	-	-	A29304	
A30288	23-7/8	16-1/2	11	20-3/4	14-3/8	10-1/8	19-5/16	300 lbs.	150 lb./5	1	A41288 (2)	A40287 (3)	6	6	-	-	A29304	
NEW! A30288MOB [‡]	Mobile A30288 bin with 3" locking casters**								200 lbs.	-	1	A41288 (2)	A40287 (3)	6	6	-	-	A29304
A30289	23-7/8	18-1/4	12	20-3/4	16	11-1/8	19-1/4	300 lbs.	150 lb./5	1	A41289 (2)	A40289 (3)	2	1	-	-	A29304	
NEW! A30289MOB [‡]	Mobile A30289 bin with 3" locking casters**								200 lbs.	-	1	A41289 (2)	A40289 (3)	2	1	-	-	A29304
A30290	29-1/4	18-3/8	12	26-1/8	16-9/16	11-3/8	24-3/4	300 lbs.	150 lb./5	1	-	A40290 (3)	-	1	A30290L	1	A29304	
NEW! A30290MOB [‡]	Mobile A30290 bin with 3" locking casters**								200 lbs.	-	1	-	A40290 (3)	-	1	-	-	A29304
A30292	29-7/8	11	10	26-3/4	9	9-1/8	25-5/16	300 lbs.	150 lb./5	4	A41287 (2)	A40292 (3)	6	6	-	-	A29304	
NEW! A30292MOB [‡]	Mobile A30292 bin with 3" locking casters**								200 lbs.	-	4	A41287 (2)	A40292 (3)	6	6	-	-	A29304
A30293	29-7/8	16-1/2	11	26-3/4	14-3/8	10-1/8	25-5/16	300 lbs.	150 lb./5	1	A41288 (2)	A40292 (3)	6	6	-	-	A29304	
NEW! A30293MOB [‡]	Mobile A30293 bin with 3" locking casters**								200 lbs.	-	1	A41288 (2)	A40292 (3)	6	6	-	-	A29304

One color per carton: Specify Red, Blue, Yellow, Clear or Gray. Not recommended to hang on rack or panel systems. Order in carton quantities. * () = Max. # of divider slots per bin. †Assembly required. **Add 3" to overall height of bin with casters.

ACCESSORIES



Hinged Lids
Available for 6 bin models



Length Dividers
Available for all sizes



Width Dividers
Available for 7 bin models



Mobile Kit
Go mobile! Transport your heaviest parts and supplies



Adhesive Labels & Card Stock Holders
Card Stock Holders fit in bins' existing slot; adhesive labels also available. See page 13

RELATED PRODUCTS
Increase the benefits of your Super-Size AkroBins with the following products



58-66 Wire Shelving Systems



67-70 Steel Shelving Systems



73 Dollies



89 Super-Size Bin Carts

Stak-N-Store Bins

STACKABLE BINS PERFECT FOR HEAVY, BULKY ITEMS



COLORS
Red, Blue, White, Clear, Gray



FEATURES

- 1 Large radius corners and rolled rim add strength
- 2 Side ribs add stability when stacked
- 3 Wide hopper front allows easy access to bulky items
- 4 Large comfort grip handles

PRODUCT HIGHLIGHTS

- **STACKBLE** – Bins stack to form tall, stable storage arrangements on floors or standard industrial shelving
- **CAPACITY** – 75-lb. weight capacity
- **DURABLE** – Industrial-grade polymer will not rust, corrode or bend out of shape even when fully loaded
- **COST-EFFECTIVE** – Longer service life resulting in lower replacement costs
- **VARIETY** – Available in 3 sizes and 5 colors: Red, Blue, Gray, White, Clear



Stak-N-Store Bins Model No.	Outside Dimensions (In.)			Inside Dimensions (In.)				Capacity/Quantity				
	L	W	H	L	W	H	X	Cu. Ft.	Gal	Lbs.	Stacking Height	Ctn. Qty.
A13014	17-1/2	10-7/8	12-1/2	15-5/8	8	12-1/4	13-1/2	.98	7.4	75	3	4
A13017*	15-1/4	19-7/8	12-7/16	13-5/8	17-1/2	12-1/4	11-1/2	1.7	12.7	75	3	3
A13018	17-1/2	16-1/2	12-1/2	15-5/8	13-3/4	12-1/4	13-1/2	1.6	12	75	3	2

One color per carton. Specify Red, Blue, Gray or Clear. *A13017 also available in White. Order in carton quantities.

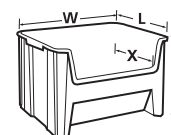

RELATED PRODUCTS

Add mobility to your Stak-N-Store Bins with



58-66 Wire Shelving Systems



67-70 Steel Shelving Systems



73 Dollies

Adhesive Labels & Card Holders

LABELING OPTIONS FOR BINS, TOTES, CONTAINERS



A69452MR

PRODUCT HIGHLIGHTS

- **FUNCTIONAL** – Can be used on a variety of Akro-Mils bins, totes and containers
- **EFFICIENT** – Perfect for 5S Lean and other productivity initiatives
- **VARIETY** – Card Stock Holders, Adhesive Labels, Adhesive Backed Card Holders available

Adhesive Labels - A29200, A29201, A29202, A29203

- Designed to fit inside card slot areas on AkroBins®, ShelfMax® Bins and Shelf Bins
- Acrylic adhesive backing forms permanent bond with bins
- Use on Akro-Mils bins, totes and containers, including AkroDrawers®, Super-Size AkroBins®, Universal Hanging Bins, ShelfMax8™, ALCs, NSTs and Stak-N-Store Bins

Card Stock Holders - A29300, A29301, A29302, A29303

- Fits into bin's existing card holder slot
- Card stock labels identify contents of bin
- Use with Shelf Bins, AkroBins, 1800 Series AkroBins, ShelfMax Bins, or Indicator Bins (see chart)

Adhesive Backed Card Holder - A29304

- Features an adhesive back to work with bins that do not have card holder slots, such as Super-Size AkroBins, 33" Wide AkroBins, Akro-Tubs, NSTs, ALCs, SWCs and Stak-N-Store Bins, ShelfMax8
- 2 3/8" x 3 7/8" surface area required



A30230 with A29203



A30240 with A29303



A30292 with A29304

Adhesive Labels	Dimensions (In.)		Works With:	Labels Per Sheet	Pkg. Qty.	Total Labels
	W	H				
A29200	1-5/8	3/4	A30110 Shelf Bin	36	10 Sheets	360
A29201	2-5/8	3/4	A30120, A30130, A30150, A30170, A30128, A30138, A30158, A30178, A30124, A30164, A30184, A30174 Shelf Bins	24	10 Sheets	240
A29202	2-5/8	7/8	A30210, A30220, A30224, A30232, A30242, AkroBins; All ShelfMax Bins; All Indicator Bins	20	10 Sheets	200
A29203	3-5/8	1-5/8	A30230, A30234, A30235, A30239, A30240, A30250, A30255, A30260, A30265, A30270 AkroBins; AkroDrawers; Super-Size AkroBins; Universal Bins; ShelfMax8 Bins; Attached Lid Containers; Nest & Stack Totes; Stak-N-Store Bins	12	10 Sheets	120

The labels were designed to fit inside our card slot area and have an acrylic adhesive backing. The approximate time for permanent bond is 48-72 hours.

Card Stock Holder	Dimensions (In.)		Works With:	Cards Per Sheet	Sheets Per Pack	Total Cards Per Pack	Total # of Clear Holders
	W	H					
A29300	3	13/16	All 4" Shelf Bins**	24	3	72	25
A29301	3	1	A30210, A30220, A30224, A30232, A30242, All ShelfMax Bins	20	3	60	25
A29302	4	1-3/4	A30230, A30234, A30235, A30239, A30240, A30250, A30255, A30348, A30358	12	3	36	25
A29303	4	2	A30260, A30265, A30270, A33223	12	3	36	25
A29304*	3-1/2	2	All Super-Size Akro-Bins, ShelfMax8 Bins, and items without Card Slots – adhesive strip on back	10	3	30	25

The clear holders for the A29300 - A29303 fit in our card slot holder. *The A29304 has an adhesive back and will work with multiple sizes of products that do not have a card slot holder such as Super-Size AkroBins, 33" Wide AkroBins, Universal Bins, ShelfMax8 Bins, Attached Lid Containers, Nest & Stack Totes, Straight Wall Containers or Stak-N-Store Bins. **Excluding A30110 (A29300 can be cut to length) 1%.

RELATED PRODUCTS

Adhesive Labels and Card Holders work with



4-5 AkroBins



6-7 Universal Hanging Bins



10-11 Super-Size AkroBins



16 Shelf Bins



17 ShelfMax

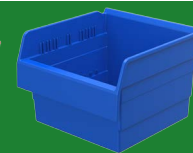

18 ShelfMax8

Divider Label Tab : Angle•Vu™ Adjustable Label Holder

5S LABELING SOLUTIONS

Divider Label Tab

CLEARLY IDENTIFY BIN CONTENTS IN SEPARATE COMPARTMENTS



A30130 with A40130 Dividers & A40000 Label Tabs

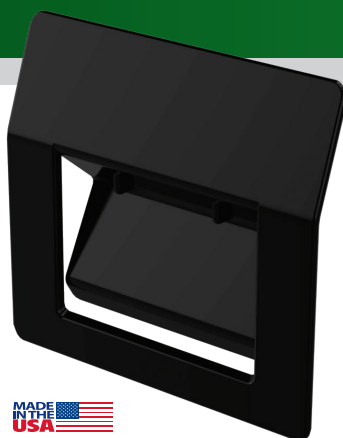

- **VERSATILE** – Works with Akro-Mils bin width dividers
- **COMPACT** – Designed to sit nearly flush with the top of Shelf Bins and ShelfMax Bins, and will not get in the way on shelving
- **FUNCTIONAL** – Fits 1" x 3" adhesive label

Divider Label Tab		Dimensions (In.)			Ctn. Qty.	Accessories
Model No.	Description	W	L	D		Adhesive Labels
A40000	Divider Label Tab	2-3/4	3-1/8	1/2	6	A29201, A29202

Angle•Vu™ Adjustable Label Holder

NO MORE CLIMBING OR BENDING TO READ OR SCAN A LABEL!



- **ADJUSTABLE** – Allows the label face to be pointed upward on low shelves and downward on high shelves
- **VERSATILE** – Works with all Akro-Mils wire shelving

Angle-Vu	Dimensions (In.)				Total No.	
Model No.	W	H	Cards Per Sheet	Sheets Per Pack	Cards Per Pack	Label Holders
A29306	3	1-1/4	16	3	48	25

Flat Label Holder

ATTACHES TO THE FACE OF WIRE SHELVING UNITS



Flat Label Holder	Dimensions (In.)				Total No.	
Model No.	W	H	Cards Per Sheet	Sheets Per Pack	Cards Per Pack	Label Holders
A29308	3	1¼	16	3	48	25

Kanban Extended Label Holders

TURN ANY BIN STORAGE SYSTEM INTO A COMPLETE KANBAN SYSTEM



FEATURES

- 1 Orange Kanban flag *slides out* to indicate bin needs refilled
- 2 Extra-large label holder face accepts up to 2" x 4" adhesive label (Akro-Mils A29203 recommended). Label face = 4-1/8" x 2-1/16"
- 3 Converts AkroBins®, 4" Shelf Bins, 6" ShelfMax® Bins, or 1800 Series AkroBins® into a single-bin Kanban system
- 4 Can be used on bins with the large label area facing upward or downward for easy viewing and scanning

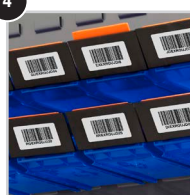
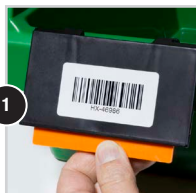

Extended Label Holders		
Model No.	Description	Ctn. Qty.
A40411	Kanban Label Holder - works with A30210, A30220, A30224, A30232, A30242 AkroBins, 4" Shelf Bins*, 6" ShelfMax Bins	24
A40412	Kanban Label Holder - works with all AkroBins except A30210, A30220, A30224, A30232, A30242, A30320; works with 1800 Series AkroBins	24
A40410**	Standard Label Holder, no flag - works with 4" Shelf Bin*, 6" ShelfMax	24

*Does not work with A30110. **Not reversible for high shelf viewing.

STANDARD LABEL HOLDER



A40410 shown with A30130

RELATED PRODUCTS

Kanban Extended Label Holders work with



4-5 AkroBins



9 1800 Series AkroBins



16 Shelf Bins



17 ShelfMax

Shelf Bins

INDUSTRY-LEADING 4" HIGH SHELF BINS ARE DURABLE, EFFICIENT

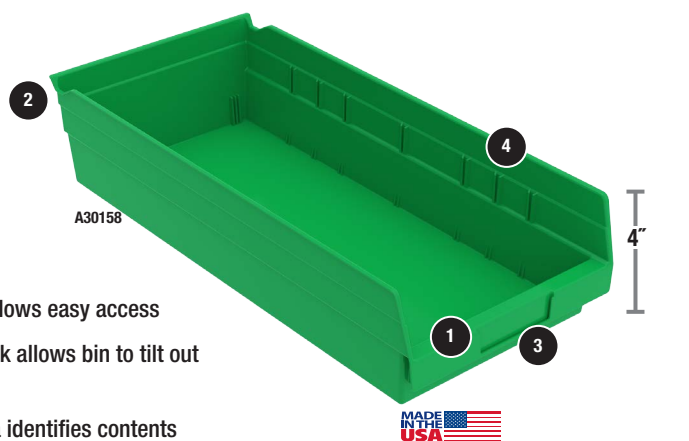

FEATURES

- 1 Wide hopper front allows easy access
- 2 Built-in rear hanglock allows bin to tilt out for complete access
- 3 Molded-in label area identifies contents
- 4 Each bin accepts up to 7 dividers (except A30110)

PRODUCT HIGHLIGHTS

- **EFFICIENT** – Shelf Bins work with 12", 18" and 24" deep shelving, pick racks or vertical storage and retrieval units
- **DURABLE** – Industrial-grade polymer bins outlast corrugated bins – paying for themselves in reduced replacement costs. Bins won't spread or crack when loaded. One-piece construction is waterproof and resistant to grease or oil
- **NESTABLE** – Shelf Bins nest when empty to conserve space
- **VARIETY** – Available in 13 sizes and 6 colors: Red, Blue, Yellow, Green, White and Clear

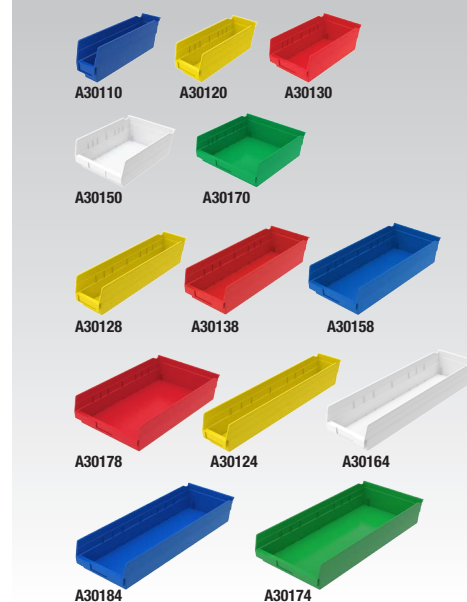

STANDARD COLORS

Red, Yellow, Blue, Green, White, Clear



Shelf Bins	Outside Dimensions (In.)			Inside Dimensions (In.)			Capacity/Quantity		Cups per Bin		Accessories				
	Model No.	L	W	H	L	W	H	Cubic Inches	Ctn. Qty.	Small A30101	Large A30102	Width Dividers*	Divider Pkg. Qty.	Labels	Card Stock
A30110	11-5/8	2-3/4	4	10-1/4	1-5/8	4	54	24	3	–	–	–	–	A29200	A29300**
A30120	11-5/8	4-1/8	4	10-1/4	3	4	78	24	5	2	A40120 (7)	24	A29201	A29300	
A30130	11-5/8	6-5/8	4	10-1/4	5-1/2	4	128	12	9	4	A40130 (7)	24	A29201	A29300	
A30150	11-5/8	8-3/8	4	10-1/4	7-1/8	4	138	12	11	4	A40150 (7)	24	A29201	A29300	
A30170	11-5/8	11-1/8	4	10-1/4	10	4	197	12	15	6	A40170 (7)	24	A29201	A29300	
A30128	17-7/8	4-1/8	4	16-1/2	3	4	123	12	8	3	A40120 (7)	24	A29201	A29300	
A30138	17-7/8	6-5/8	4	16-1/2	5-1/2	4	176	12	15	6	A40130 (7)	24	A29201	A29300	
A30158	17-7/8	8-3/8	4	16-1/2	7-1/8	4	214	12	15	6	A40150 (7)	24	A29201	A29300	
A30178	17-7/8	11-1/8	4	16-1/2	10	4	292	12	25	12	A40170 (7)	24	A29201	A29300	
A30124	23-5/8	4-1/8	4	22-1/8	3	4	199	12	11	4	A40120 (7)	24	A29201	A29300	
A30164	23-5/8	6-5/8	4	22-1/8	5-1/2	4	321	6	21	8	A40130 (7)	24	A29201	A29300	
A30184	23-5/8	8-3/8	4	22-1/8	7-1/8	4	346	6	25	8	A40150 (7)	24	A29201	A29300	
A30174	23-5/8	11-1/8	4	22-1/8	10	4	513	6	35	16	A40170 (7)	24	A29201	A29300	

One color per carton: Specify Red, Blue, Yellow, Green, White or Clear. Order in carton quantities. * () = Max. # of divider slots per bin. **A29300 must be cut to length to fit A30110.

AVAILABLE IN
CLEAR
CLEAR

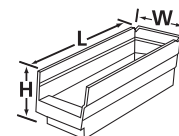

ACCESSORIES



Width Dividers
Available for all sizes (except A30110)



Kanban Extended Label Holders
Turn your bin storage system into a complete Kanban system (see page 15)



Adhesive Labels & Card Stock Holders
Card stock holders fit in bins' existing slot; Adhesive labels also available (see page 13)

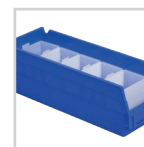

Bin Cups
Lift out easily for parts retrieval (see chart)

Bin Cups	Outside Dimensions (In.)			Ctn. Qty.
Model No.	L	W	H	
A30101	2	3-1/4	3	48
A30102	2-3/4	5	3	24

ShelfMax® Bins

6" HIGH SHELF BINS MAXIMIZE STORAGE CAPACITY

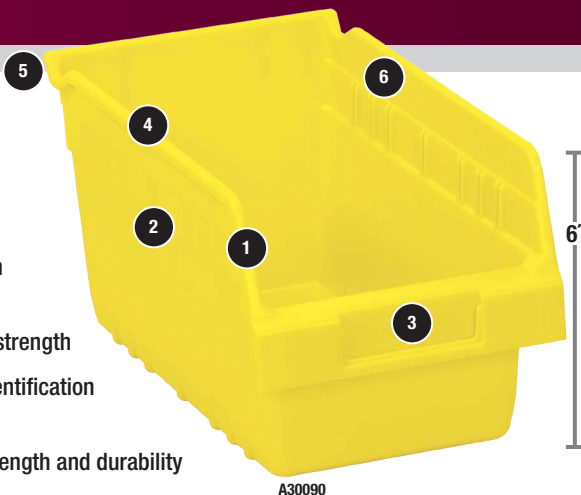

A30090

FEATURES

- 1 Front opening is $\frac{3}{4}$ " higher than comparable 6" products
- 2 Reinforced side ribs for added strength
- 3 Large label area aids in part identification and bar code scanning
- 4 Rolled ridge provides added strength and durability when filled to capacity
- 5 Built-in rear hanglock allows bin to tilt out for complete access
- 6 Optional dividers create additional storage options

PRODUCT HIGHLIGHTS

- **CAPACITY** – Bins offer 85% more storage than traditional 4" bins
- **EFFICIENT** – Works with steel shelving, wire shelving, pick racks and bench racks
- **DURABLE** – Superior construction compared to corrugated bins
- **VARIETY** – Available in 12 sizes and 4 colors: Red, Blue, Yellow and Clear

ShelfMax Model No.	Outside Dimensions (In.)			Inside Dimensions (In.)			Capacity/Quantity		Accessories NEW!			
	L	W	H	L	W	H	Cubic Inches	Ctn. Qty.	Black Width Dividers*	Clear Width Dividers*	Divider Pkg. Qty.	Card Stock
A30040	11-5/8	4-1/8	6	9-3/4	2-1/2	5-15/16	175	16	A40020 (7)	A40020CRY (7)	12	A29301
A30090	11-5/8	6-5/8	6	9-3/4	5	5-15/16	310	10	A40030 (7)	A40030CRY (7)	12	A29301
A30080	11-5/8	8-3/8	6	9-3/4	6-5/8	5-15/16	398	8	A40040 (7)	A40040CRY (7)	12	A29301
A30010	11-5/8	11-1/8	6	9-3/4	9-1/2	5-15/16	591	8	A40050 (7)	A40050CRY (7)	12	A29301
A30048	17-7/8	4-1/8	6	16	2-1/2	5-15/16	280	8	A40020 (7)	A40020CRY (7)	12	A29301
A30098	17-7/8	6-5/8	6	16	5	5-15/16	505	10	A40030 (7)	A40030CRY (7)	12	A29301
A30088	17-7/8	8-3/8	6	16	6-5/8	5-15/16	648	8	A40040 (7)	A40040CRY (7)	12	A29301
A30018	17-7/8	11-1/8	6	16	9-1/2	5-15/16	963	8	A40050 (7)	A40050CRY (7)	12	A29301
A30044	23-5/8	4-1/8	6	21-3/4	2-1/2	5-15/16	410	16	A40020 (7)	A40020CRY (7)	12	A29301
A30094	23-5/8	6-5/8	6	21-3/4	5	5-15/16	686	10	A40030 (7)	A40030CRY (7)	12	A29301
A30084	23-5/8	8-3/8	6	21-3/4	6-5/8	5-15/16	935	6	A40040 (7)	A40040CRY (7)	12	A29301
A30014	23-5/8	11-1/8	6	21-3/4	9-1/2	5-15/16	1303	6	A40050 (7)	A40050CRY (7)	12	A29301

One color per carton: Specify Red, Blue, Yellow or Clear. Order in carton quantities. * () = Max. # of divider slots per bin.

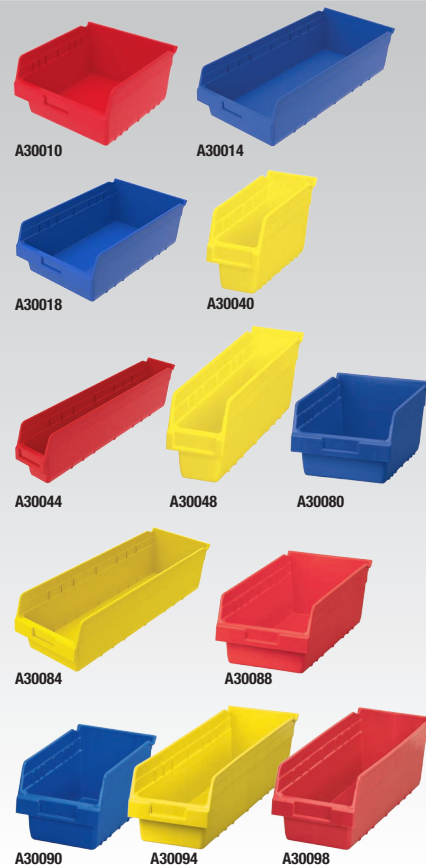

COLORS

Red, Yellow, Blue, Clear

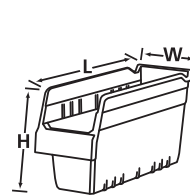
AVAILABLE IN
CLEAR
CRYSTAL

A30090

ACCESSORIES



Black Width Dividers
Available for all sizes

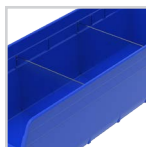

Clear Width Dividers
Available for all sizes



Adhesive Labels & Card Stock Holders
Card stock holders fit in bins' existing slot; Adhesive labels also available (See page 13)



Kanban Extended Label Holders
Turn your bin storage system into a complete Kanban system (See page 15)

RELATED PRODUCTS

Create the perfect storage solution — mix and match your ShelfMax Bins with these products



41-43 Pick Rack Systems



58-66 Wire Shelving Systems



67-70 Steel Shelving Systems

ShelfMax8™ Bins

EXTRA-LARGE, 8-INCH HIGH, FOR MAXIMUM STORAGE CAPACITY

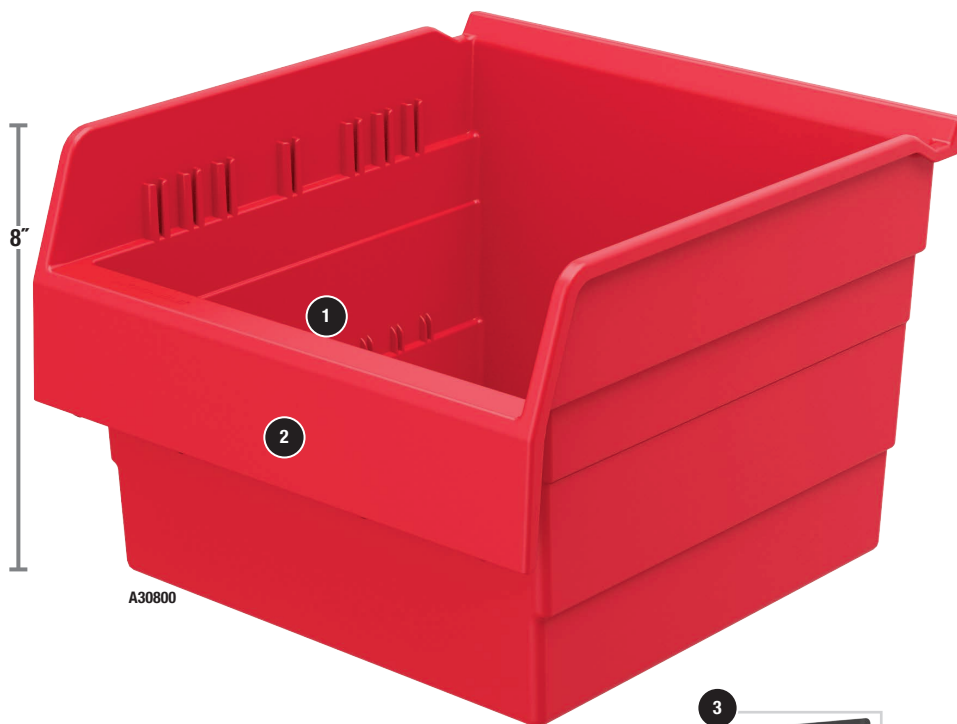

A30800



FEATURES

- 1 Bins feature a wide hopper front for easy access and a built-in rear hanglock to allow complete access to contents when tilted out on shelving
- 2 The oversized label area easily accommodates a 2' high adhesive label, or multiple adhesive labels for divided bins holding multiple SKUs
- 3 An innovative new divider design allows for more secure bin partitions along with easier installation and removal

PRODUCT HIGHLIGHTS

- **VERSATILE** – Sizes designed for standard shelving systems and many Vertical Carousel Automated Storage Retrieval Systems
- **CAPACITY** – Up to 95% more holding capacity than traditional 4" shelf bins, and 65% more capacity than 6" bins
- **VARIETY** – Available in 23 sizes and 4 colors: Red, Blue, Yellow and Clear



A30800



A30804



A30806



A30808



A30814



A30818



A30820

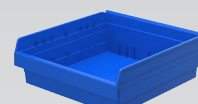

A30824



A30826



A30828

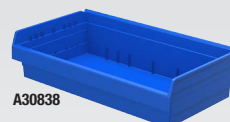

A30838



A30840



A30844



A30846



A30848



A30860



A30864



A30866



A30868



A30880



A30884



A30886



A30888

COLORS

Red, Yellow, Blue, Clear



A30860

ShelfMax8 Bins

ShelfMax8 Model No.	Outside Dimensions (In.)			Inside Dimensions (In.)			Capacity/Quantity			Accessories				
	L	W	H	L	W	H	Cubic Inches	U.S. Gal.	Ctn. Qty.	Black Width Dividers*	Clear Width Dividers*	Divider Pkg. Qty.	Length Dividers*	Divider Pkg. Qty.
A30840	11-5/8	4-1/8	8	9-3/8	2-9/16	7-15/16	233	1.01	16	A40840 (7)	A40840CRY (7)	12	-	-
A30860	11-5/8	6-5/8	8	9-3/8	5	7-15/16	411	1.78	10	A40860 (7)	A40860CRY (7)	12	-	-
A30880	11-5/8	8-1/4	8	9-3/8	6-5/8	7-15/16	520	2.25	8	A40880 (7)	A40880CRY (7)	12	-	-
A30800	11-5/8	11-1/8	8	9-3/8	9-7/16	7-15/16	734	3.18	4	A40800 (7)	A40800CRY (7)	12	-	-
A30820	11-5/8	22-1/2	8	8-15/16	20-1/4	7-15/16	1638	7.09	4	A40820 (7)	A40820CRY (7)	6	A41820 (7)	12
A30866	15-5/8	6-5/8	8	13-3/8	5	7-15/16	585	2.53	10	A40860 (7)	A40860CRY (7)	12	-	-
A30886	15-5/8	8-1/4	8	13-3/8	6-5/8	7-15/16	740	3.20	8	A40880 (7)	A40880CRY (7)	12	-	-
A30806	15-5/8	11-1/8	8	13-3/8	9-7/16	7-15/16	1044	4.52	4	A40800 (7)	A40800CRY (7)	12	-	-
A30868	17-7/8	6-5/8	8	15-5/8	5	7-15/16	672	2.91	10	A40860 (7)	A40860CRY (7)	12	-	-
A30888	17-7/8	8-1/4	8	15-5/8	6-5/8	7-15/16	851	3.68	8	A40880 (7)	A40880CRY (7)	12	-	-
A30808	17-7/8	11-1/8	8	15-5/8	9-7/16	7-15/16	1200	5.19	4	A40800 (7)	A40800CRY (7)	12	-	-
A30818	17-7/8	16-1/2	8	15-3/16	14-7/16	7-15/16	1897	8.21	4	A40818 (7)	A40818CRY (7)	6	A41818 (7)	6
A30828	17-7/8	22-1/2	8	15-3/16	20-1/4	7-15/16	2545	11.02	4	A40820 (7)	A40820CRY (7)	6	A41818 (7)	6
A30844	23-5/8	4-1/8	8	21-3/8	2-9/16	7-15/16	529	2.29	8	A40840 (7)	A40840CRY (7)	12	-	-
A30864	23-5/8	6-5/8	8	21-3/8	5	7-15/16	932	4.03	10	A40860 (7)	A40860CRY (7)	12	-	-
A30884	23-5/8	8-1/4	8	21-3/8	6-5/8	7-15/16	1179	5.10	8	A40880 (7)	A40880CRY (7)	12	-	-
A30804	23-5/8	11-1/8	8	21-3/8	9-7/16	7-15/16	1662	7.19	4	A40800 (7)	A40800CRY (7)	12	-	-
A30814	23-5/8	16-1/2	8	20-15/16	14-7/16	7-15/16	2533	10.97	4	A40818 (7)	A40818CRY (7)	6	A41814 (7)	6
A30824	23-5/8	22-1/2	8	20-15/16	20-1/4	7-15/16	3523	15.25	4	A40820 (7)	A40820CRY (7)	6	A41814 (7)	6

One color per carton. Specify Red, Blue, Yellow or Clear. Order in carton quantities. * () = Max. # of divider slots per bin.

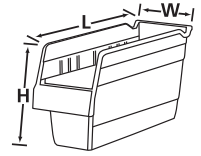

ACCESSORIES

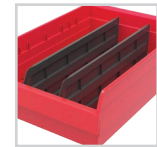

Length Dividers
Available for 7 bin models

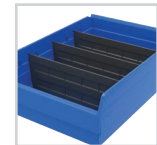

Black Width Dividers
Available for all sizes



Clear Width Dividers
Available for all sizes



Adhesive Labels
Clearly identify bin contents (See page 13)

Dual-Sided Picking/Stocking Cart

SPECIALTY CART FOR SHELFMAX8 BINS

PRODUCT HIGHLIGHTS

- **VERSATILE** – 4 angled shelves and a flat bottom shelf can transport stock or supplies throughout the facility
- **VARIETY** – 2 bin sizes available: A30806 and A30826; 4 bin colors: Red, Blue, Yellow, Clear



RACR30806GY



RACR30826BGY

UP TO
1000
LBS.

Stocking Cart		Outside Dimensions (In.)			Bin Dimensions (In.)			Capacity	
Model No.	Description	L	W	H	L	W	H	Caster Type	Lbs.
RACR30806	Cross-Stack Stocking Cart with 32 - A30806 ShelfMax8 Bins	53	29	62	15-5/8	11-1/8	8	5" Mold-On Rubber	1000
RACR30826	Cross-Stack Stocking Cart with 16 - A30826 ShelfMax8 Bins	53	29	62	15-5/8	22-1/2	8	5" Mold-On Rubber	1000

Specify color of ShelfMax8 Bins when ordering: Red, Blue, Yellow or Clear.

Indicator® Bin

TWO-TONE INVENTORY CONTROL BIN

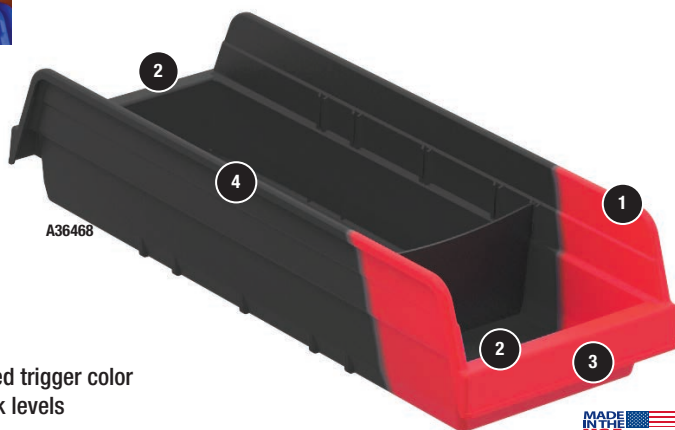

A36468

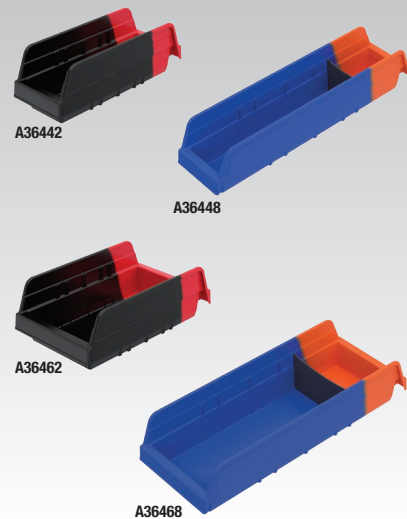

A36442

A36448

A36462

A36468

COLORS

Blue/Orange, Black/Red



FEATURES

- 1 Bright orange/red trigger color shows low stock levels
- 2 Innovative double-hopper bin can be filled or picked from both sides
- 3 Large label area on both sides of bin
- 4 Rolled ridge provides added strength and durability
- 5 Width dividers (sold separately) used to separate reserve stock

PRODUCT HIGHLIGHTS

- **INVENTORY CONTROL** – Prevents stockouts with visual recognition when supplies need to be replenished
- **EASY TO USE:**
 - STOCK* – using the divider to designate volume for the inventory reserve
 - PICK* – from the blue/black side of the bin until you reach the divider
 - FLIP* – the bin to the orange/red reserve to show inventory levels are low
 - REPLENISH* – the bin and repeat!
- **VALUE** – Low-cost alternative to high-end inventory control systems

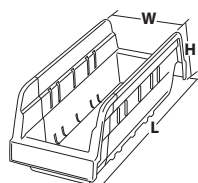

Stock Pick Flip Replenish



Indicator Bins		Outside Dimensions (In.)			Inside Dimensions (In.)			Accessories		
Model No.	Description	L	W	H	L	W	H	Bin Ctn. Qty.	Dividers*	Divider Pkg. Qty.
A36442BLUE	Blue/Orange Bin	11-5/8	4-1/4	4	9-7/8	2-7/8	3-7/8	24	A40120	24
A36442BLKRED	Black/Red Bin	11-5/8	4-1/4	4	9-7/8	2-7/8	3-7/8	24	A40120	24
A36448BLUE	Blue/Orange Bin	17-7/8	4-1/8	4	16-1/8	2-3/4	3-7/8	12	A40442	12
A36448BLKRED	Black/Red Bin	17-7/8	4-1/8	4	16-1/8	2-3/4	3-7/8	12	A40442	12
A36462BLUE	Blue/Orange Bin	11-5/8	6-3/4	4	9-7/8	5-3/8	3-7/8	12	A40130	24
A36462BLKRED	Black/Red Bin	11-5/8	6-3/4	4	9-7/8	5-3/8	3-7/8	12	A40130	24
A36468BLUE	Blue/Orange Bin	17-7/8	6-5/8	4	16-1/8	5-1/4	3-7/8	12	A40462	12
A36468BLKRED	Black/Red Bin	17-7/8	6-5/8	4	16-1/8	5-1/4	3-7/8	12	A40462	12

*Dividers sold separately.

ACCESSORIES

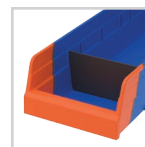

Width Dividers
Available for all sizes



Adhesive Labels
Adhesive labels are ideal for bin content identification. (See page 13)

RELATED PRODUCTS

Create the perfect storage solution – mix and match your Indicator Bins with these products

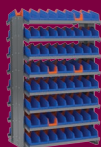

41-43 Pick Rack Systems



58-66 Wire Shelving Systems



67-70 Steel Shelving Systems

AkroDrawers®

HEAVY-DUTY STORAGE DRAWERS

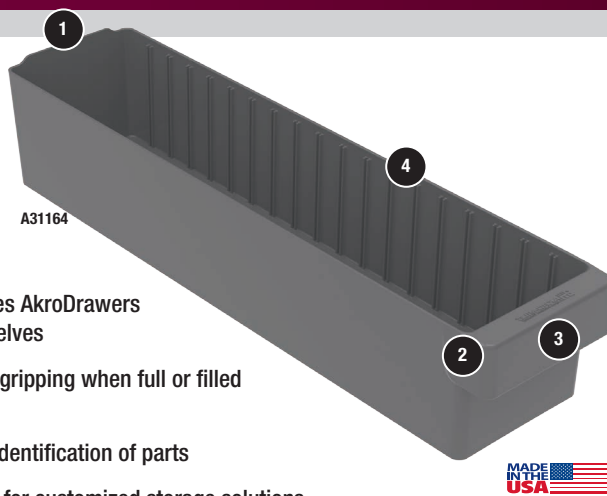

FEATURES

- 1 Sturdy backstop tab ensures AkroDrawers can hang securely from shelves
- 2 Wide front handle for easy gripping when full or filled with heavy contents
- 3 Large label area for quick identification of parts
- 4 Multiple divider slots allow for customized storage solutions

PRODUCT HIGHLIGHTS

- **PARTS PROTECTION** – AkroDrawers help keep your supplies, tools and parts secure and dust-free
- **FUNCTIONAL** – Drawers can be used with Akro-Mils' Super Modular Cabinets, Stackable Cabinets, Secure Mini-Cabinets, Louvered Carts, Pick Racks and Enclosed Steel Shelving
- **DURABLE** – Color drawers made of high-impact polystyrene; Crystal Clear drawers made of a durable acrylic blend
- **STACKABLE** – AkroDrawers can be stacked to optimize space
- **VARIETY** – Available in 9 sizes and 5 colors: Red, Yellow, Blue, Crystal Clear, Gray

AkroDrawers®

AkroDrawers Model No.	Outside Dimensions (In.)			Inside Dimensions (In.)			Capacity/Qty.		Dividers*	Pkg. Qty
	L	W	H	L	W	H	Weight Capacity	Ctn. Qty.		
A31142	11-5/8	3-3/4	4-5/8	10-1/4	3-1/16	4-7/16	15 lbs.	6	A41440 (8)	6
A31148	17-5/8	3-3/4	4-5/8	16-1/4	3-1/16	4-7/16	20 lbs.	6	A41440 (13)	6
A31162	11-5/8	5-9/16	4-5/8	10-1/4	4-7/8	4-7/16	20 lbs.	6	A41460 (8)	6
A31168	17-5/8	5-9/16	4-5/8	16-1/4	4-7/8	4-7/16	25 lbs.	6	A41460 (13)	6
A31164	23-7/8	5-9/16	4-5/8	22-1/2	4-7/8	4-7/16	25 lbs.	6	A41460 (18)	6
A31182	11-5/8	8-3/8	4-5/8	10-1/4	7-5/8	4-7/16	20 lbs.	4	A41480 (8)	6
A31188	17-5/8	8-3/8	4-5/8	16-1/4	7-5/8	4-7/16	25 lbs.	4	A41480 (13)	6
A31112	11-5/8	11-1/8	4-5/8	10-1/4	10-7/16	4-7/16	25 lbs.	4	A41410 (8)	8
A31118	17-5/8	11-1/8	4-5/8	16-1/4	10-7/16	4-7/16	25 lbs.	4	A41410 (13)	8

Specify drawer color when ordering: Red, Blue, Yellow, Gray or Crystal Clear. *(*) = Max. # of divider slots per bin.

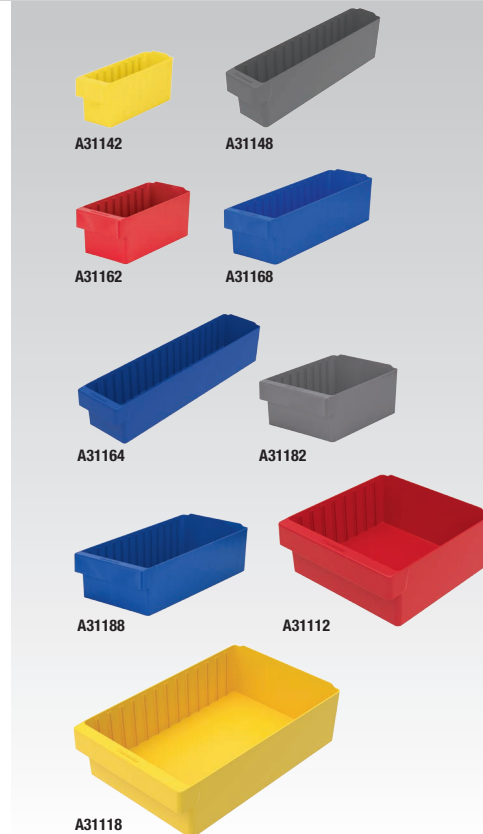

COLORS

Red, Yellow, Blue, Crystal Clear, Gray



AVAILABLE IN
CLEAR
CRYSTAL



A31168

ACCESSORIES

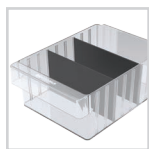

Width Dividers
Available for
all sizes



Adhesive Labels
Adhesive labels are ideal
for content identification
and form a permanent
bond with bins. (See
page 13)

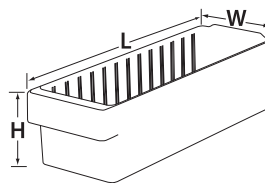

RELATED PRODUCTS

Create the perfect storage solution — mix and match your AkroDrawers with these products

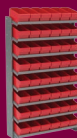

41-43 Pick
Rack Systems



55 Secure
Mini-Cabinets

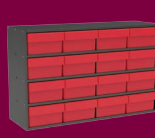

56 Stackable
Cabinets



57 Super
Modular Cabinets



68 Enclosed
Steel Shelving



86-87 Louvered
Carts

System Bins™ : Economy Bins

NESTING / STACKING BINS



System Bins™

SINGLE-PIECE, 6-COMPARTMENT STORAGE UNIT



A30318

MADE
IN THE
USA

PRODUCT HIGHLIGHTS

- **SINGLE-PIECE** – Configured six-across in a single unit, 33" wide by 5" high; bins are sized to fit on 36" wide steel and wire shelving
- **VALUE** – A cost-effective alternative to flimsy, cardboard boxes
- **DURABLE** – Sturdy interior double-wall construction. One-piece, injection-molded
- **STACKABLE** – Can be safely stacked using a 3/8" wood dowel rod (not included)
- **NESTABLE** – Bins nest when empty to conserve space
- **VARIETY** – Available in 12" or 18" depths. Colors: Red, Yellow, Blue

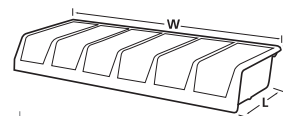
COLORS
Red, Yellow, Blue

System Bins™

System Bins		Dimensions (In.)			Bin Compartment Dimensions (In.)**			Ctn. Qty.
Model No.	Description	L	W	H	L	W	H	
A30312	12" System Bin	12	33	5	10-3/8	3-5/8	4-15/16	5
A30318	18" System Bin	18	33	5	16-3/8	3-5/8	4-15/16	5
A40312*	System Bin Divider (Black only)	5/32	4-7/8	4-7/8	-	-	-	6 pk.

One color per carton: Specify Red, Blue or Yellow. Order in carton quantities. *One divider per compartment, six per unit. **Bottom inside dimension per compartment.

Economy Bins

NESTING & STACKING SHELF BIN

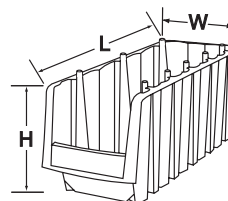

A30716

MADE
IN THE
USA
COLOR
Black

Economy Bins	Outside Dimensions (In.)			Inside Dimensions (In.)			Ctn. Qty.
Model No.	L	W	H	L	W	H	
A30796BLACK	8-7/8	6-5/8	5	6-3/25	4	4-9/10	10
A30716BLACK	11-7/8	6-5/8	5	9-3/25	4	4-9/10	10
A30776BLACK	17-7/8	6-5/8	7	14-8/9	3-4/5	6-9/10	10
A30718BLACK	11-7/8	8-3/8	5	9	5-3/4	4-9/10	8
A30778BLACK	17-7/8	8-3/8	7	14-4/5	5-1/2	6-9/10	8

Order in carton quantities.

- **VERSATILE** – Economy Bins make full use of shelf space on 12" or 18" deep shelving and stack to fill space between shelves
- **DURABLE** – Industrial-grade polymer construction
- **EXCLUSIVE** – The only small parts bin that can nest and stack
- **EFFICIENT** – Generous bin opening allows easy access to items

AK HSN Bins

AK-West HSN Bins

HANGING - STACKING - NESTING

NEW!



AKW220

AKW235

AKW210



AKW250

PRODUCT HIGHLIGHTS

- Hang when using on louvered panels
- Stack when using on shelves or work tables
- Nest for shipping and storage!
- Available with length and width dividers
- Stocked in Red, Yellow and Blue

COLORS

Red, Yellow, Blue



AK Bins	Outside Dimensions (In.)			Bin Ctn. Qty.	Accessories		
	Model No.	L	W		H	Black Length Dividers†	Black Width Dividers‡
AKW210	5-3/8	4-1/8	3	36	HSNDIV210LAK	-	6
AKW220	7-3/8	4-1/8	3	36	HSNDIV220LAK	HSNDIV220WAK	6
AKW230	10-7/8	5-1/2	5	24	HSNDIV230LAK	HSNDIV230WAK	6
AKW235	10-7/8	11	5	12	-	HSNDIV235WAK	6
AKW239	10-3/4	8-1/4	7	12	HSNDIV239LAK	-	6
AKW240	14-3/4	8-1/4	7	16	-	HSNDIV240WAK	8
AKW250	14-3/4	16-1/2	7	8	HSNDIV250LAK	HSNDIV250WAK	8

Available in blue, red & yellow

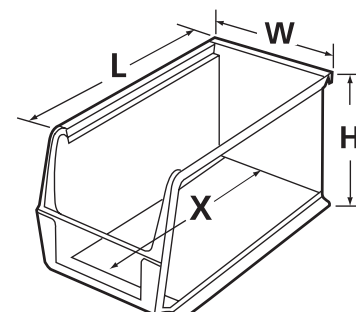

Nest & Stack Totes

EXTREMELY DURABLE INDUSTRIAL-GRADE TOTES



A35200

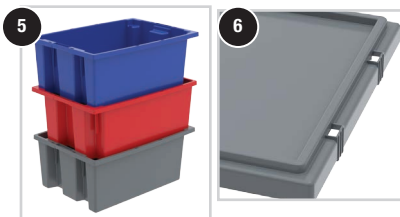

ACCESSORIES



Lids
Protect contents from dust and damage, include tie holes



Clear Plastic Label Holders
Accommodate labels up to 3 3/4" x 5"

Label Holders		
Model No.	Pkg. Qty.	Label Size (In.)
A35010	6	3-3/4 x 5
A35011	6	3 x 5



A35300

COLORS

Red, Blue, Grey, Clear

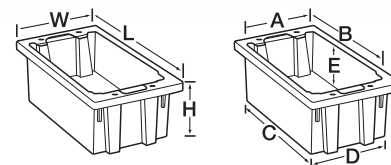

FEATURES

- 1 Smooth surfaces are easy to clean
- 2 Comfortable grip makes handling easy
- 3 Ribs under the lip prevent jamming when nested
- 4 Textured bottoms provide a no-slip grip on conveyor belts
- 5 Wide stacking ledge allows totes to securely stack without lids in place
- 6 Lids have tie holes for extra security

PRODUCT HIGHLIGHTS

- **FUNCTIONAL** – Ideal for shipping, transfer and storage applications
- **STACKBLE** – NSTs stack with or without lids for storage and shipping
- **NESTABLE** – Totes nest when empty
- **DURABLE** – Strong, industrial-grade polymer will not rust, corrode or bend out of shape even when fully loaded
- **COST-EFFECTIVE** – Long service life resulting in lower replacement costs
- **FDA-SANCTIONED** – NSTs are manufactured from FDA-sanctioned materials
- **VARIETY** – Available in 9 sizes and 4 colors: Red, Blue, Grey, Clear
- **CUSTOMIZE** – Custom colors and hot stamping available

Nest & Stack Totes (NSTs)	Outside Dimensions (In.)			Inside Dimensions (In.)					Capacity/Qty.				Accessories			
	Model No.	L	W	H	A	B	C	D	E	Cu. Ft.	Gal	Lbs.	Total Ctn. Qty.	Stacking Height	Lid Model	Lid Ctn. Qty.
A35180	18	11	6	10	15	14-3/8	9-3/8	5-7/8	0.5	3.7	45	6	6	A35181	6	–
A35185	18	11	9	10	15	14-1/8	9-1/8	8-7/8	0.76	5.69	60	6	6	A35181	6	–
A35190	19-1/2	15-1/2	10	14-1/2	15-1/2	14-3/4	13-1/2	9-7/8	1.2	9	65	6	6	A35191	6	–
A35195	19-1/2	15-1/2	13	14-1/2	15-1/2	14-5/8	13-3/8	12-7/8	1.7	12.93	85	6	6	A35191	6	–
A35200	19-1/2	13-1/2	8	12-3/8	15-3/4	15-1/4	11-1/2	7-7/8	0.8	6.1	55	6	6	A35201	6	–
A35225	23-1/2	19-1/2	10	18-1/4	19-3/8	18	16-7/8	9-7/8	2	14.98	70	3	6	A35231	3	RU843HR1822
A35230	23-1/2	19-1/2	13	18-1/8	19-3/8	18	16-7/8	12-7/8	2.6	19.4	90	3	6	A35231	3	RU843HR1822
A35240	23-1/2	15-1/2	12	14-1/4	19-3/8	18-1/4	13	11-7/8	1.7	12.9	75	3	6	A35241	3	RU843HR1422
A35300	29-1/2	19-1/2	15	18-1/4	25	23-1/2	16-5/8	14-7/8	3.7	27.4	100	3	6	A35301	3	RU843HR1828

One color per carton. Specify color: Red, Blue, Grey or Clear. Order in carton quantities.



SN21141200



SN20161200



AC11037E15



SN24160800



SN24160822



SN24161222



AG191405



AG201604



AG24160752



SN24161622

Nest & Stack Totes (NSTs)	Description	Available Colour	Outside Dimensions (In.)		
			L	W	H
SN21141200	180 DEGREE STACK AND NEST / 018-510 (132)	GREY	21	14	12
SN20161200	HD STACK & NEST /018-610 (162)	GREY	20	16	12
C18-702E	HEAVY DUTY STACK AND NEST CONTAINER (69)	BLUE, GREEN	32	18	12
AC11037E15	600 x 400 x 236 mm Stanck and Nest (120)	ORANGE	-	-	-
AC11020E06BC	Stack and Nest W/HOLES (270)	Grey	24	16	4
SN24160800	Stack and Nest Container NO HOLES / 11032 (150)	GREY	24	16	8
SN24160822	Stack and Nest Container W/HOLES / 11034 (150)	GREY	24	16	8
SN24161200	Stack and Nest Container NO HOLES / 11051 (115)	GREY	24	16	12
SN24161222	Stack and Nest Container W/HOLES / 11052 (115)	GREY	24	16	12
SN24161600	Stack and Nest Container NO HOLES / 11065 (80)	GREY	24	16	16
SN24161622	Stack and Nest Container W/HOLES / 11066 (80)	GREY	24	16	16
007-641	STACK & NEST BOTTOM DRAIN HOLES	ORANGE	19	19	10
007-640	STACK & NEST NO DRAIN HOLES	LT BLUE	19	19	10
007-644	STACK & NEST VETILATED	GREEN	23	18	12
007-648	STACK & NEST BOTTOM DRAIN HOLES	BEIGE	22	14	14
AG191405	18.75 X 13.63 X 4.56 VENTILATED STACK AND NEST TRAY	BEIGE	19	14	5
AG201604	19.5 X 16.38 X 4.19 VENTILATED STACK AND NEST TRAY	GREY	19	16	4
AG201605	19.5 X 16.38 X 5 VENTILATED STACK AND NEST TRAY	GREY	20	16	5
AG24160752	24 x 16 1/8 x 7 1/4	GREY	24	16	7
Picking Baskets					
007-670	15" DIAMETER X 13" TALL PICKING BASKET w/VENTILATION	GREEN	-	15	13
007-671	15" DIAMETER X 13" TALL PICKING BASKET / SOLID	RED	-	15	13
007-678	12" DIAMETER X 13" 1/2 BASKET	RED	-	12	13



C18-702E



007-678



007-670



007-648



007-644



007-640

Akro-Grid

DIVIDABLE GRID CONTAINERS

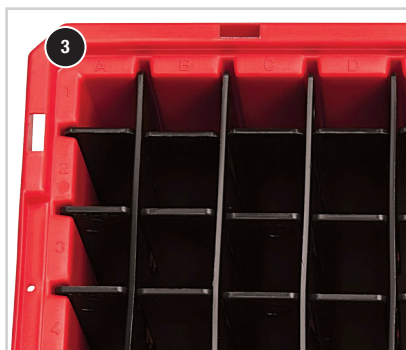
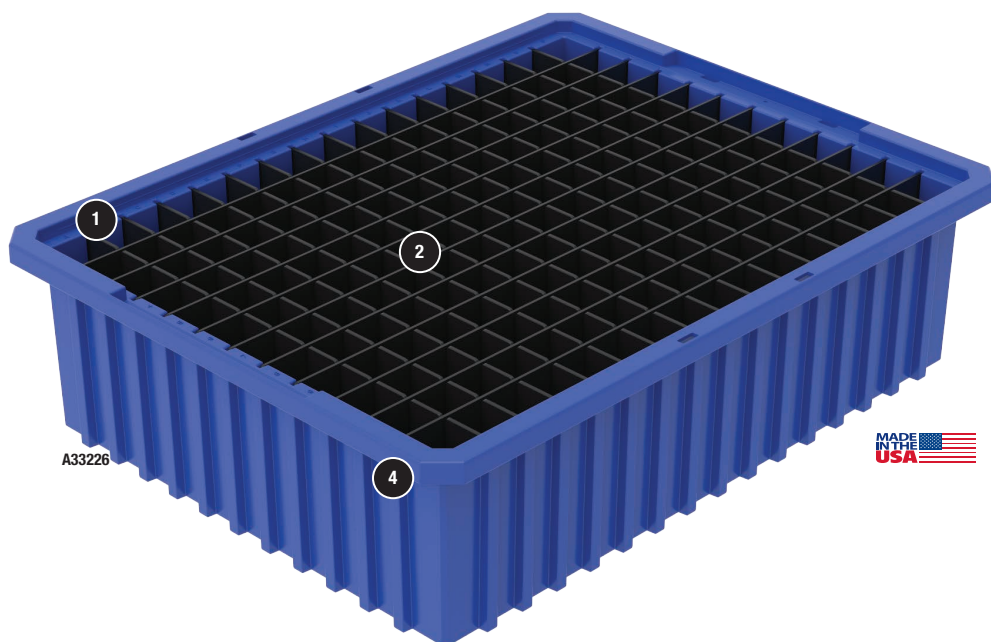

FEATURES

- 1 Divider slots allow you to create hundreds of compartment sizes
- 2 Dividers (sold separately) allow subdivision of the containers to a 1 1/8" square compartment size
- 3 Molded-in letter/number system for easy parts tracking
- 4 Strong stacking rims and external ribbing provide added strength

PRODUCT HIGHLIGHTS

- **FUNCTIONAL** – Compatible with most racks, shelving and automated storage retrieval systems
- **DURABLE** – Injection-molded from industrial-grade polymers. Resists most solvents and chemicals
- **COST-EFFECTIVE** – Longer service life resulting in lower replacement costs
- **VARIETY** – Available in 13 sizes and 4 colors: Red, Blue, Clear, Gray
- **CUSTOMIZE** – Custom colors and hot stamping available



A33103



A33105



A33162



A33164



A33165



A33166



A33168

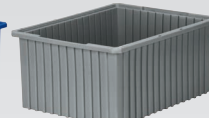

A33220



A33222



A33223



A33224



A33226



A33228

COLORS

Red, Blue, Clear, Gray



A33105

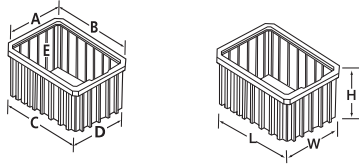

Akro-Grids Model No.	Outside Dimensions (In.)			Inside Dimensions (In.)					Capacity/Qty.				Accessories				
	L	W	H	A	B	C	D	E	Cu. Ft.	Gal	Lbs.	Bin Ctn. Qty.	Long Divider*	Short Divider*	Divider Pkg. Qty.	Max. No. of Compartments	Steel Dollies
A33103	10-7/8	8-1/4	3-1/2	6-9/16	9-3/16	9-1/8	6-7/16	3-3/8	0.12	0.92	25	20	A42103 (5)	A41103 (7)	6	48	-
A33105	10-7/8	8-1/4	5	6-11/16	9-5/16	9-1/8	6-1/2	4-5/8	.16	1.2	25	20	A42105 (5)	A41105 (7)	6	48	-
A33162	16-1/2	10-7/8	2-1/2	9-3/16	14-13/16	14-3/4	9-1/8	2-3/8	0.20	1.5	20	12	A42162 (7)	A41162 (7)	6	96	-
A33164	16-1/2	10-7/8	4	9-3/8	14-15/16	14-13/16	9-3/16	3-7/8	.29	2.2	20	12	A42164 (7)	A41164 (11)	6	96	-
A33165	16-1/2	10-7/8	5	9-3/16	14-13/16	14-5/8	9	4-7/8	0.39	2.9	35	12	A42165 (7)	A41165 (11)	6	96	-
A33166	16-1/2	10-7/8	6	9-5/16	14-7/8	14-3/4	9-1/8	5-9/16	.44	3.3	35	8	A42166 (7)	A41166 (11)	6	96	-
A33168	16-1/2	10-7/8	8	9-5/16	14-15/16	14-5/8	9-1/16	7-9/16	.59	4.4	40	6	A42168 (7)	A41168 (11)	6	96	-
A33220	22-3/8	17-3/8	10	15-1/4	20-1/8	19-7/8	14-7/8	9-7/8	1.66	12.4	50	2	A42220 (11)	A41220 (15)	6	192	RU843HR1621
A33222	22-1/2	17-1/2	12	15-5/16	20-5/16	19-15/16	14-15/16	11-13/16	2.10	15.9	60	3	A42222 (11)	A41222 (15)	6	192	RU843HR1621
A33223	22-1/2	17-3/8	3	15-7/16	20-1/2	20-7/16	15-3/8	2-1/2	.47	3.5	30	6	A42223 (11)	A41223 (15)	6	192	RU843HR1621
A33224	22-3/8	17-3/8	4	15-1/16	20-1/16	20	15	3-7/8	.61	4.6	30	6	A42224 (11)	A41224 (15)	6	192	RU843HR1621
A33226	22-3/8	17-3/8	6	15-1/8	20-1/8	19-7/8	14-7/8	5-7/8	.96	7.2	40	4	A42226 (11)	A41226 (15)	6	192	RU843HR1621
A33228	22-3/8	17-3/8	8	15-1/8	20-1/8	19-7/8	14-7/8	7-7/16	1.30	9.7	50	3	A42228 (11)	A41228 (15)	6	192	RU843HR1621

One color per carton. Specify Red, Blue, Gray or Clear. Order in carton quantities. *(1) = max # of dividers.

Clear Snap-On Lids Model No.	Outside Dimensions (In.)			Fits Grid No.	Ctn. Qty.
	L	W	H		
A33011	11-1/2	8-11/16	15/16	A33103, A33105	10
A33061	17-3/16	11-5/16	15/16	A33162, A33164, A33165, A33166, A33168	4
A33023	23-5/16	18-1/16	15/16	A33220, A33222, A33223, A33224, A33226, A33228	3

Label Holders		
Model No.	Fits Grid No.	Pkg. Qty.
A35010	Fits all except A33103, A33162, A33164, A33223, A33224	6
A35011	A33164, A33224	6

Adhesive Label		
Model No.	Fits Grid No.	Pkg. Qty.
A29203	A33103, A33162, A33223	10 sheets (120 total)

ACCESSORIES



Dividers
Allow subdivision of the containers down to 1 1/8" square compartments



Clear Plastic Label Holders
Snap securely on any side of the container (except A33223)



Clear Snap-On Lids
Durable injection-molded lids keep contents clean yet visible

RELATED PRODUCTS

Create the perfect storage solution, pair your Akro-Grids with



58-66 Wire Shelving Systems



73 Dollies



84 ProCart



Multi-Load Tote

DESIGNED FOR MINI-LOAD AUTOMATED STORAGE AND RETRIEVAL SYSTEMS (AS/RS)



FEATURES

- 1 Reinforced bottom, ribbed side walls and a reinforced rim for added strength and stability
- 2 Straight walls for efficient cubing on pallets and AS/RS systems
- 3 Designated 2" x 4" label areas on length side of tote provide consistent scanning and allow for easy tote orientation at picking stations
- 4 The unique sidewall clip design allows cups and dividers to attach quickly and securely to the tote
- 5 Solid reinforced bottom has large flat areas for a smooth and quiet ride on conveyors

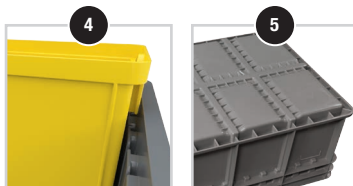

PRODUCT HIGHLIGHTS

- **FUNCTIONAL** – Versatile tote for general storage and logistics applications
- **DURABLE** – Injection-molded from industrial-grade polymers; patented design allows dividers and cups to remain stable and secure in the most demanding applications



A38358GRY



A38004



A38008

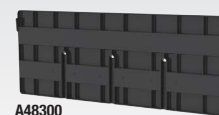

A48300

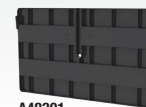

A48301

COLOR

Gray



Dividers cross link to create 4 to 8 sturdy compartments.

Multi-Load Totes & Cups		Outside Dimensions (mm)			Outside Dimensions (In.)			Capacity/Qty.		
Model No.	Description	L	W	H	L	W	H	Cu. Ft.	Lbs.	Ctn. Qty.
A38358GRY	Multi-Load Tote - Gray	600	400	220	23-5/8	15-3/4	8-21/32	1.50	80	4
A38008YEL	1/8 Cup - Yellow	184	136	210	7-1/4	5-3/8	8-9/32	0.14	-	12
A38004RED	1/4 Cup - Red	369	136	210	14-17/32	5-3/8	8-9/32	0.29	-	6
A48300	Length Divider - Black	-	-	-	-	-	-	-	-	1
A48301	Width Divider - Black	-	-	-	-	-	-	-	-	3

Order in carton quantities.

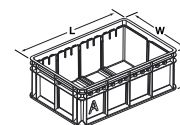

ACCESSORIES



Length Dividers
Have crosslink tabs that can be removed when used with width dividers



Width Dividers
Have crosslink tabs that can be removed when used with length dividers



1/4 Bin Cup
Create up to 4 secure compartments



1/8 Bin Cup
Create up to 8 secure compartments

Straight Wall Containers

INDUSTRIAL REUSABLE CONTAINERS



MADE IN THE USA



A37208



A37678



A37682



A37616

FEATURES

- 1 1" wall thickness for secure stacking
- 2 Strong 1" wide stacking rims and external ribbing provide added strength
- 3 Straight walls provide efficient cubing in trucks and on pallets
- 4 Open .72 x .90 mesh pattern allows high visibility and good airflow
- 5 Large handles on 4 sides for easy and comfortable grip

COLORS

Red, Gray



PRODUCT HIGHLIGHTS

- **FUNCTIONAL** – Reusable shipping, storage and work-in-process containers
- **SOLID** – Smooth inner walls for easy, sanitary cleaning
- **MESH** – Allow air ventilation and drainage
- **DURABLE** – Injection-molded from industrial-grade polymers
- **VARIETY** – Available in 12 configurations, 4 sizes and 2 colors: Red, Gray
- **CUSTOMIZE** – Custom colors and hot stamping available

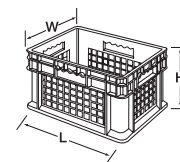

Straight Wall Containers (SWCs)			Outside Dimensions (In.)			Inside Dimensions Bottom (In.)			Capacity/Qty.			Stacked Capacity/Qty.		Accessories
Model No. Mesh Side & Base	Model No. Mesh Side/Solid Base	Model No. Solid Side & Base	L	W	H	L	W	H	Cu. Ft.	Gal.	Container Ctn. Qty.	Solid Bottom	Mesh Bottom	Steel Dollies
A37208	A37278	A37288	15-3/4	11-3/4	8-1/4	14	10	8	0.89	5.12	12	83 lbs./6	30 lbs./6	–
A37608	A37678	A37688	23-3/4	15-3/4	8-1/4	22	14	8	1.78	11.19	4	83 lbs./6	45 lbs./6	RU843HR1624
A37612	A37672	A37682	23-3/4	15-3/4	12-1/4	22	14	12	2.67	8.32	3	125 lbs./5	45 lbs./5	RU843HR1624
A37616	A37676	A37686	23-3/4	15-3/4	16-1/8	22	14	16	3.55	11.07	2	150 lbs./4	45 lbs./4	RU843HR1624

Order in carton quantities. Specify color when ordering.

RELATED PRODUCTS

Add more productivity to your Straight Wall Containers with



58-66 Wire Shelving Systems



73 Dollies

Akro-Tubs

FOOD PROCESSING OR INDUSTRIAL TOTES



MADE IN THE USA

FEATURES

- 1 Rolled top rim forms comfortable handles
- 2 Extra-thick walls for superior strength
- 3 Rounded corner design adds strength to stress points
- 4 Ribs prevent jamming when nested

PRODUCT HIGHLIGHTS

- **FDA-SANCTIONED** – Tub manufactured from FDA-sanctioned materials
- **SMOOTH SURFACE** – Easy to clean
- **NESTABLE** – Nests when empty to conserve space

Akro-Tub	Outside Dimensions (In.)					Capacity/Qty.			
Model No.	L	W	H	A	B	Cu. Ft.	Gal.	Lbs.	Ctn. Qty.
A34240	24-1/2	19	9-1/2	20-1/2	15-1/2	1.95	14.6	75	6
RA6TR4MR	24	24	73	-	-	-	-	600	-

Order in carton quantities.

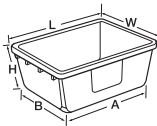
COLOR
Gray

AKRO-TUB RACK

Model No. RA6TR4MR
Holds 6 Akro-Tubs for up to 600 lb. total capacity. Welded steel frame with 12-gauge base and bolted-on casters (A34240 Akro-Tubs sold separately). Casters: 4" x 2" Mold-On Rubber: 2 Rigid, 2 Swivel

UP TO
600
LBS.

Cross-Stack Akro-Tubs

FEATURES

- 1 Stacking grooves allow stable 90° stacks
- 2 Molded-in handles for easy lifting
- 3 Extra-thick walls and reinforcing ribs provide superior strength
- 4 Lid available for A34305

JL25160800
with lid

MADE IN THE USA

PRODUCT HIGHLIGHTS

- **FDA-SANCTIONED** – Tub manufactured from FDA-sanctioned materials
- **FUNCTIONAL** – Industrial-grade tub is compatible with standard 36" shelving and conveyor systems
- **NESTABLE** – Nesting when empty conserves storage space
- **STACKABLE** – Cross-stacking with or without lids
- **SMOOTH SURFACE** – Easy to clean

Cross-Stack Akro-Tub	Outside Dimensions (In.)					Accessories	Capacity/Qty.		
Model No.	L	W	H	A	B	Lid	Cu. Ft.	Gal.	Ctn. Qty.
A34301	17-1/4	11	8	13-1/4	7-3/4	-	0.52	3.85	6
A34302	17-1/4	11	12	12-5/8	7	-	0.74	5.51	6
A34303	23-3/4	17-1/4	8	19-3/4	14	-	1.31	9.81	6
A34304	23-3/4	17-1/4	12	19	13-1/4	-	1.92	14.38	6
JL25160800	25	16	8-1/2	-	-	LJ251602000	-	7.48	-
RACR5MR	53	29	62	-	-	-	-	1000	-

One color per carton. **Available in Blue, Gray or Natural. Specify color. Order in carton quantities.

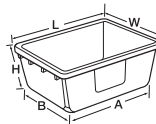

COLORS

Gray, Blue, Natural



JL25160800

Available in Gray, Blue, Yellow, Green, Red & Natural

DOUBLE-SIDED CROSS-STACK AKRO-TUB RACK

Model No. RACR5MR
Holds (32) A34301 or (16) A34303 Cross-Stack Akro-Tubs (sold separately). Casters: 5" x 2" Mold-On Rubber: 2 Rigid, 2 Swivel

UP TO
1000
LBS.

Cross-Stack Akro-Tub Racks

FOR INDUSTRIAL, MEDICAL, RESTAURANT OR OTHER FOOD APPLICATIONS

FEATURES

- 1 Unique "C" channel rail design allows tubs to hang; tubs won't fall down
- 2 Optional rubber stops keep tubs from sliding out during transport
- 3 Work-height shelf on 3-Tub Unit provides additional work area

PRODUCT HIGHLIGHTS

- **VARIETY** – Holds 3 or 6 of the A34305 tubs; 4 caster options available
- **DURABLE** – Made of 16-gauge steel with a powder-coated finish
- **CUSTOMIZABLE** – All-steel construction with 2 sizes, 3 tub colors and 4 caster options

NEW!



RA3JLR3SRGY with
JL25160800

**MADE
IN THE
USA**



RA6JLR3POGY

Cross-Stack Akro-Tub Racks		Outside Dimensions (In.)			Caster Type	Capacity
Model No.	Description	L	W	H		Lbs.
RA3JLR3POGY	Rack with Top Shelf holds (3) A34305 Akro-Tubs	19-1/2	25-1/2	36	3" Polyolefin	300
RA3JLR3TPGY	Rack with Top Shelf holds (3) A34305 Akro-Tubs	19-1/2	25-1/2	36	3" Thermo-Plastic	300
RA3JLR5SRGY	Rack with Top Shelf holds (3) A34305 Akro-Tubs	19-1/2	25-1/2	36	5" Soft Rubber	300
RA3JLR4MRGY	Rack with Top Shelf holds (3) A34305 Akro-Tubs	19-1/2	25-1/2	36	4" Mold-On Rubber	300
RA6JLR3POGY	Rack holds (6) A34305 Akro-Tubs	19-1/2	25-1/2	66-5/8	3" Polyolefin	600
RA6JLR3TPGY	Rack holds (6) A34305 Akro-Tubs	19-1/2	25-1/2	66-5/8	3" Thermo-Plastic	600
RA6JLR5SRGY	Rack holds (6) A34305 Akro-Tubs	19-1/2	25-1/2	66-5/8	5" Soft Rubber	600
RA6JLR4MRGY	Rack holds (6) A34305 Akro-Tubs	19-1/2	25-1/2	66-5/8	4" Mold-On Rubber	600

Akro-Tubs sold separately - available in Blue, Gray or Natural.

Caster Styles:



Mold-On Rubber



Polyolefin



Thermo-Plastic



Soft Rubber

Easy Flow Gravity Hopper

HOPPER SYSTEM WITH COMPACT VERTICAL DESIGN



FEATURES

- 1 Large angled top opening for easy filling
- 2 Generous picking area provides easy access to loaded product
- 3 First-In-First-Out (FIFO) sliding divider shelf for time-sensitive inventory (for A31620 hopper only)

PRODUCT HIGHLIGHTS

- **FUNCTIONAL** – Allows for proper lot rotation. Great for fasteners, assembly areas, Kanban, inventory stock, merchandise and work cells
- **CAPACITY** – A31620: 50 lbs.; A31625: 75 lbs.
- **DURABLE** – Rotational-molded for strength and durability
- **VARIETY** – Available in 2 sizes and 2 colors. A31625 available in Red and Blue; A31620 available in Blue only

Easy Flow Gravity Hopper		Dimensions (In.)				Capacity/Qty.			
Model No.	Description	L	W	H	D	Cu. In.	Gal.	Lbs.	Ctn. Qty.
A31620 [‡]	Small Easy Flow Gravity Hopper	16	8-1/4	16	10	1400	6	50	1
A31625	Large Easy Flow Gravity Hopper	18	10-3/4	19-1/2	8	2400	10.39	75	1

When ordering A31625 specify color Red or Blue. [‡] Sliding divider shelf with A31620 hopper only.

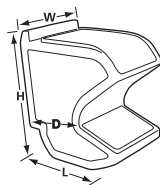

Accessories		
Model No.	Description	Wt. Cap.
A31625RACK	Easy Flow Gravity Hopper Rack 36" x 36" x 69"	900 lbs.
A30600DOLLY	Easy Flow Gravity Hopper Dolly with 4" x 1-1/2" Polyolefin Casters	900 lbs.
A30600BRACKET	Easy Flow Gravity Hopper Bracket	75 lbs.



A31620



A31625

COLORS

Red, Blue



GRAVITY HOPPER FLOOR RACK

Model No. A31625RACK
Holds 9 large or 12 small hoppers per side. 13-gauge steel powder-coated rack has a 900-lb. weight capacity. Hoppers sold separately



ACCESSORIES



A30600DOLLY
Optional dolly to mobilize A31625RACK has 4 swivel casters (2 with brakes)



A30600BRACKET
Optional bracket to hang hoppers from louvered panels or rail racks



Rail Hanging Systems

IDEAL SYSTEMS FOR WORKSTATIONS



FEATURES

- 1 14-gauge steel rails securely support AkroBins®, 19-Series Cabinets and InSight® Ultra-Clear Bins (sold separately)
- 2 Heavy-duty steel for strength and durability
- 3 Durable powder-coated finish

PRODUCT HIGHLIGHTS

- **EFFICIENT** – Allow for fast, easy organization and parts retrieval
- **SINGLE-SIDED** – Units are ideal for placement against a wall to save space
- **DOUBLE-SIDED** – Units can “float” in any room environment and can be picked from both sides
- **MOBILE KIT** – Available to mobilize two-sided rack
- **STEEL RAIL** – Wall mountable rail is ideal for supply rooms and workstations



COLOR
Gray



HOW TO CHOOSE: Rails vs. Louvers

Rails: Constructed of individual steel rails that span between uprights. Weigh less than louvered panels, more economical, small footprint, easy to remove bins from rails.

Louvers: (Page 34) Steel panels with rows of punched louvers. More storage capacity, greater selection of styles. Panels can be attached to the wall, freeing floor space. Rivet racks come with the panels already riveted to the frame.

Rail Hanging Systems				Dimensions (In.)			AkroBins Model No.*													InSight Bins †				19-Series Cabinets	
Model No.	Description	Wt. Cap.	Ctn. Qty.	L	W	H	A30210	A30220	A30224	A30230	A30234	A30235	A30237	A30239	A30240	A30250	A30255	A30260	A30265	A30270	305A1	305A3	305A5	305B1	
A30008*	Rack, 1-Sided	250	1	36	14-1/8	53	96	96	64	48	48	24	40	24	24	12	16	12	16	8	96	96	96	48	6
A30016*	Rack, 2-Sided	500	1	36	20	53	192	192	128	96	96	48	80	48	48	24	32	24	32	16	192	192	192	96	12
A30148	Steel Rail	110	1	47-13/16	5/8	3	11	11	11	8	8	4	8	5	5	2	2	4	5	2	11	11	11	8	2
A30812	Bin Cart	250	1	38-1/2	24	36-1/2	96	96	64	48	48	24	40	24	24	12	16	12	16	8	96	96	96	48	12

*Can be assembled as a 12 or 16 rail rack. †Do not exceed rail weight capacity.

Mobile Kit					
Model No.	Description	Wt. Cap.	Ctn. Qty.	Fits Hanging System No.	Casters
A30424	Mobile Kit - Casters & Handle	500	1	A30016	4" Polyolefin
A98400	Suspension Straps (Set of 2) ‡‡	—	1	A30008, A30016, A30812	—

‡‡ A98400 suspension straps required for hanging 19-Series Cabinets. Two straps per cabinet needed to secure cabinet to rack.

ACCESSORIES

Suspension Straps
Model No A98400
Hang 19-Series Cabinets securely to rail rack



A30016 with (1) A30424, (12) A98400, (12) A19320

Louvered Hanging Systems : Louvered Rack Dollies

CUSTOMIZABLE VERTICAL STORAGE FOR HANGING BINS



UP TO
2000
LBS.

HOW TO CHOOSE: Louvers vs. Rails

Louvers: Steel panels with rows of punched louvers. More storage capacity, greater selection of styles. Panels can be attached to the wall, freeing floor space. Rivet racks come with the panels already riveted to the frame.

Rails: (Page 33) Constructed of individual steel rails that span between uprights. Weigh less than louvered panels, more economical, small footprint, easy to remove bins from rails.



FEATURES

- 1 Louvered Panels securely support AkroBins® and InSight® Bins (sold separately, see Pgs. 4, 8)
- 2 Heavy-duty 16-gauge, cold-rolled steel for strength and durability
- 3 Attractive, durable powder-coated finish
- 4 Save installation time with Rivet Racks! Models A30661, A30638 and A30676 are full louvered panels mounted to a heavy-duty frame



PRODUCT HIGHLIGHTS

- **EFFICIENT** – Wall-mounted units keep items out of the way, off the floor and off the work table
- **FLOOR RACKS** – Can be placed near work areas to improve productivity
- **SINGLE-SIDED RACKS** – Can be placed against a wall to save floor space
- **DOUBLE-SIDED RACKS** – Expand storage options
- **MOBILE KITS** – Available to mobilize racks; easily relocate supplies without unloading bins

WALL PANELS

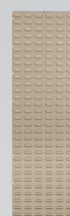
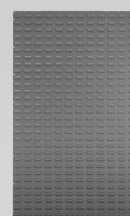
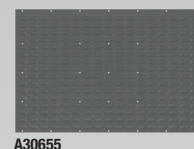
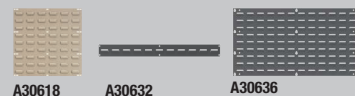

HEAVY-DUTY FLOOR RACKS

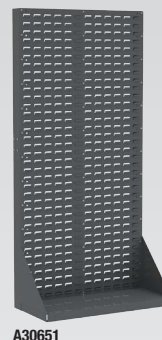

RIVET FLOOR RACKS

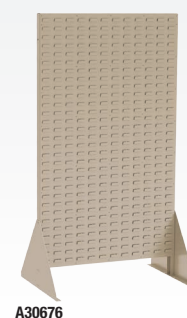

COLORS
Gray, Beige



AkroBin Louvered Hanging Systems			Dimensions (In.)				AkroBin Quantity to Fit Louvered Hanging System – AkroBins Model No.														
Model No.	Description	Ctn. Qty	L	W	H	Rack Wt. Cap. (lbs.)	A30210	A30220	A30224	A30230	A30234	A30235	A30237	A30239	A30240	A30250	A30255	A30260	A30265	A30270	A30320
A30618**	Louvered Wall Panel	4	18	5/16	19	160	16	16	12	9	9	3	6	4	4	2	3	1	2	1	–
A30632**	Single Row Lvd Panel	2	2	31-15/16	5/16	80	7	7	7	5	5	2	5	3	3	1	1	2	3	1	–
A30636**	Louvered Wall Panel	4	35-3/4	5/16	19	160	32	32	24	18	18	9	15	8	8	4	6	3	4	2	3
	2 Louvered Wall Panels		35-3/4	5/16	37	–	72	72	48	36	36	18	30	16	16	8	12	9	12	6	6
	3 Louvered Wall Panels		35-3/4	5/16	55	–	104	104	72	54	54	27	45	24	24	12	18	12	20	8	9
	4 Louvered Wall Panels		35-3/4	5/16	73	–	144	144	96	72	72	36	60	36	36	18	24	18	28	12	12
A30655	Louvered Wall Panel	1	52	5/16	34-1/8	750	96	96	60	45	45	20	40	24	24	12	15	8	18	6	5
A30161**	Louvered Wall Panel	1	36	5/16	61	1000	120	120	80	60	60	30	50	28	28	14	20	15	24	10	10
A30118**	Louvered Wall Panel	1	18	5/16	61	500	60	60	40	30	30	10	20	14	14	7	10	5	12	5	–
A30651	Heavy-Duty Single-Sided Floor Rack	1	35-3/4	17	75-1/8	1000	144	144	96	72	72	36	60	36	36	18	24	18	28	12	12
A30653	Heavy-Duty Double-Sided Floor Rack	1	35-3/4	32	75-1/8	2000	288	288	192	144	144	72	120	72	72	36	48	36	56	24	24
A30638	Single-Sided Rivet Floor Rack	1	18	13-1/2	66-3/8	250	60	60	40	30	30	10	20	14	14	7	10	5	12	5	–
A30658	Double-Sided Rivet Floor Rack	1	18	25	66-3/8	500	120	120	80	60	60	20	40	28	28	14	20	10	24	10	–
A30661*	Single-Sided Rivet Floor Rack	1	36-3/16	13-1/2	66-3/8	500	120	120	80	60	60	30	50	28	28	14	20	15	24	10	10
A30676*	Double-Sided Rivet Floor Rack	1	36-3/16	25	66-3/8	1000	240	240	160	120	120	60	100	56	56	28	40	30	48	20	20
A30653DOLLY	Mobile Kit for A30653	1	–	–	–	500	–	–	–	–	–	–	–	–	–	–	–	–	–	–	–
LVDMOBILE	Mobile Kit for A30676	1	–	–	–	1500	–	–	–	–	–	–	–	–	–	–	–	–	–	–	–
A30661DOLLY	Gray Floor Rack Dolly for A30661	1	37	24	6	500	–	–	–	–	–	–	–	–	–	–	–	–	–	–	–

*Also available in Beige. †Also available in Textured White. Specify color when ordering. Beige = BEIGE, White = TEXWHT, GY = Gray.



A30636BEIGE with 305A3

InSight Louvered Panel Systems		
Model No.	Description	Bin Qty.
A30636BEIGE A1	35-3/4" x 19" Louvered Wall Panel with A305A1	32
A30636BEIGE A3	35-3/4" x 19" Louvered Wall Panel with A305A3	32

InSight Louvered Panel Systems		
Model No.	Description	Bin Qty.
A30636BEIGE A5	35-3/4" x 19" Louvered Wall Panel with A305A5	32
A30636BEIGE B1	35-3/4" x 19" Louvered Wall Panel with A305B1	18

Louvered Rack Dollies

EASILY MOVE FULLY LOADED RACKS



NEW!



RELATED PRODUCTS

Racks and panels can be used with a variety of bins:



4-5 AkroBins



6-7 Universal Hanging Bins

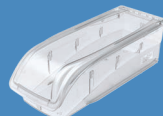

8 InSight Bins



32 Easy Flow Gravity Hopper

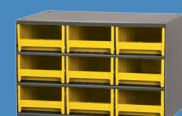

48 19-Series Cabinets

Louvered Hanging System Accessories: AkroShelf™ : Louvered Panel Hooks

MAXIMIZE YOUR VERTICAL STORAGE SYSTEMS

Louvered Panel Hooks

HOOKS FOR LOUVERED PANELS

PRODUCT HIGHLIGHTS

- **FLEXIBILITY** – customize storage for odd-shaped items such as sanding disks, rolls of tape, hoses and tools

Louvered Panel Hooks		Capacity/Qty.	
Model No.	Description	Wt. Cap. (lbs.)	Pkg. Qty.
LPP6SP	Straight Post - 6" Long	10	6
LPP6WL	Wide Loop - 6" Long - 3" Long x 2-3/4" Wide	20	6
LPP6NL	Narrow Loop - 6" Long x 1-1/2" Wide	20	6
LPP3SP	Straight Post - 3" Long	10	6
LPP3WL	Wide Loop - 3" Long x 2-3/4" Wide	20	6
LPP3NL	Narrow Loop - 3" Long x 1-1/2" Wide	20	6

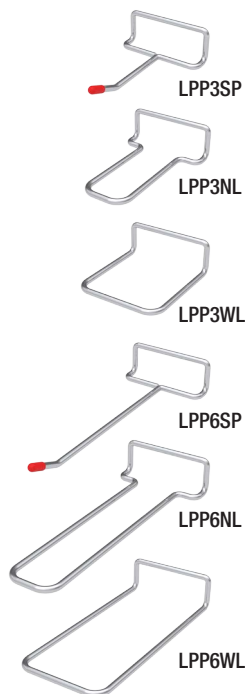

A30676 with LVDMOBILE and Louvered Panel Hooks

NEW! Pegboard Bin Adapters

NOW HANG BINS ON PEGBOARD OR SLAT WALL!

Welded-metal construction provides secure hanging on standard pegboard and slatwall. Two sizes allow for customization of storage space. Large Adapter 10-2/3" Long A30112, Small Adapter 5" Long A30111

Pegboard Adapters	
Model No.	Length Ins.
A30111	5
A30112	10-2/3



AkroShelf™

ADD SHELVES TO LOUVERED PANELS

FEATURES

- 1 Slides down securely onto louvered panels; can be quickly removed
- 2 "Bracket Up" option creates a bottom shelf
- 3 "Bracket Down" option creates a top shelf

AkroShelf		Shelf Dimensions (In.)			Capacity (Lbs.)	Ctn. Qty.
Model No.	Description	W	L	H		
A30635GY	AkroShelf	12-3/4	35-5/8	6-7/16	50	4
A30635AGY	AkroShelf	12-3/4	35-5/8	6-7/16	50	1

Caution: Not to be used as a step.

COLORS
Gray, Beige



Low Profile Louvered Floor Racks

CUSTOMIZABLE COMPACT STORAGE FOR HANGING BINS



FEATURES

- 1 Heavy-duty 16-gauge, cold-rolled steel for strength and durability
- 2 Optional shelf adds additional workspace
- 3 Attractive, durable powder-coated finish



A30650GY

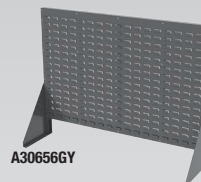

A30656GY

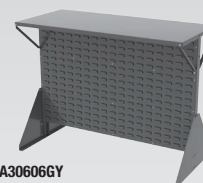

A30606GY



A30607GY



A30606DOLLY shown with A30606GY

COLOR
Gray



Low Profile Floor Rack – Single-Sided		Rack Dimensions (In.)			Bin Dimensions (In.)		Wt. Capacity (Lbs.)				
Model No.	Description	W	H	D	Bin Model No.	L	W	H	Bin Qty.	Panel/Top	Colors
A30650GY	Low Profile Floor Rack	52-5/8	40	13-1/2	–	–	–	–	–	500/250	–
A30650GY240	Low Profile Floor Rack	52-5/8	40	13-1/2	A30240	14-3/4	8-1/4	7	24	500/250	B, R, Y, SC
A30650GY250	Low Profile Floor Rack	52-5/8	40	13-1/2	A30250	14-3/4	16-1/2	7	12	500/250	B, R, Y, SC
A30650GYASST	Low Profile Floor Rack	52-5/8	40	13-1/2	A30240 / A30250	See Above			12 / 6	500/250	B, R, Y, SC
A30656GY	Low Profile Floor Rack no Shelf	52-5/8	39-7/8	13-1/2	–	–	–	–	–	500	B, R, Y, SC
A30656GY240	Low Profile Floor Rack no Shelf	52-5/8	39-7/8	13-1/2	A30240	14-3/4	8-1/4	7	24	500	B, R, Y, SC
A30656GY250	Low Profile Floor Rack no Shelf	52-5/8	39-7/8	13-1/2	A30250	14-3/4	16-1/2	7	12	500	B, R, Y, SC
A30656GYASST	Low Profile Floor Rack no Shelf	52-5/8	39-7/8	13-1/2	A30240 / A30250	See Above			12 / 6	500	B, R, Y, SC

Specify color of bins when ordering. B=Blue, R=Red, Y=Yellow, SC=Clear.

Low Profile Floor Rack – Double-Sided		Rack Dimensions (In.)			Bin Dimensions (In.)		Wt. Capacity (Lbs.)				
Model No.	Description	W	H	D	Bin Model No.	L	W	H	Bin Qty.	Panel/Top	Colors
A30606GY	Low Profile Floor Rack	52-5/8	40	27	–	–	–	–	–	500 per side/250	–
A30606GY240	Low Profile Floor Rack	52-5/8	40	27	A30240	14-3/4	8-1/4	7	48	500 per side/250	B, R, Y, SC
A30606GY250	Low Profile Floor Rack	52-5/8	40	27	A30250	14-3/4	16-1/2	7	24	500 per side/250	B, R, Y, SC
A30606GYASST	Low Profile Floor Rack	52-5/8	40	27	A30240 / A30250	See Above			24 / 12	500 per side/250	B, R, Y, SC
A30607GY	Low Profile Floor Rack no Shelf	52-5/8	39-7/8	27	–	–	–	–	–	500	B, R, Y, SC
A30607GY240	Low Profile Floor Rack no Shelf	52-5/8	39-7/8	27	A30240	14-3/4	8-1/4	7	48	500	B, R, Y, SC
A30607GY250	Low Profile Floor Rack no Shelf	52-5/8	39-7/8	27	A30250	14-3/4	16-1/2	7	24	500	B, R, Y, SC
A30607GYASST	Low Profile Floor Rack no Shelf	52-5/8	39-7/8	27	A30240 / A30250	See Above			24 / 12	500	B, R, Y, SC
A30606DOLLY	Dolly for A30606 or A30607	53	5-7/8	27-1/2	–	–	–	–	–	3600*	–

Specify color of bins when ordering. B=Blue, R=Red, Y=Yellow, SC=Clear. *Do not exceed weight capacity of Low-Profile Rack.

Benchtop Spinner Rack : Louvered Bench Rack

LOUVERED TABLETOP STORAGE SPACE FOR HANGING BINS



Double-Sided Benchtop Spinner Rack

TABLETOP STORAGE SPACE IN A COMPACT 18" FOOTPRINT

FEATURES

- 1 18" W x 32" H louvered panel
- 2 Frame components are made of 16-gauge steel with a durable powder-coated finish
- 3 Four roller bearings allow for smooth revolving on base
- 4 Can be permanently mounted to any work surface for added stability

UP TO 200 LBS.

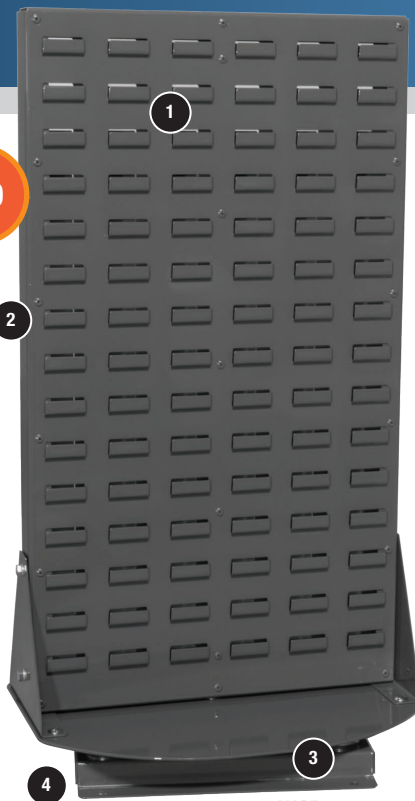

MADE IN THE USA

Double-Sided Benchtop Spinner Rack			Dimensions (In.)			Rack Wt. Cap. (lbs.)*	Bin Quantity – AkroBin Model No.					Universal Hanging Bin Model No.		19-Series Cabinet	COLOR
Model No.	Description	Ctn. Qty	W	D	H		A30210	A30220	A30224	A30230	A30237	A36110	A36120		Gray
A98318GY	Benchtop Spinner Rack	1	18-1/2	16	34-1/4	200	56	56	40	30	20	40	20	4	

*Weight evenly distributed on both sides of unit.

AkroBin Louvered Benchtop Rack Packages			
Model No.	Description	Bin Model No.	Bin Qty.
A98318GY2430	Rack with AkroBins	A30224 / A30230	24 / 12
A98318GY2055	Rack with AkroBins	A30220 / A30255	24 / 6

Specify color of bins when ordering, B=Blue, R=Red, Y=Yellow, SC=Clear.

ACCESSORIES

Suspension Straps
Model No A98400
Hang 19-Series Cabinets securely to Benchtop Rack



Louvered Bench Rack

KEEP PARTS AND SUPPLIES IN EASY REACH



A98600 with A30220

MADE IN THE USA

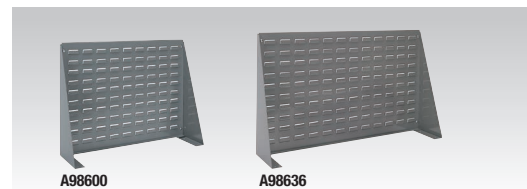

COLORS
Gray, Beige



Louvered Bench Rack			Dimensions (In.)			Rack Wt. Cap. (lbs.)	AkroBin Quantity to Fit Louvered Hanging System – AkroBins Model No.													
Model No.	Description	Ctn. Qty	L	W	H		A30210	A30220	A30224	A30230	A30234	A30235	A30237	A30239	A30240	A30250	A30255	A30260	A30265	A30320
A98600*	Bench Rack	1	27-15/16	8-9/16	19-9/16	120	30	30	18	12	12	6	12	6	6	2	3	2	6	-
A98636	Bench Rack	1	36	8	20	120	40	40	24	18	18	9	15	8	8	4	6	3	8	3

*Also available in Beige.

ReadySpace® Storage System

BIN HANGING SYSTEMS FOR MEDICAL & PHARMACY

Ready, Set, Organize!®

PRODUCT HIGHLIGHTS

- **CLEAN** – Durable white powder-coated finish creates a neat, attractive storage space in any medical or pharmacy environment
- **MOBILE FLOOR UNIT** – Lockable casters transport supplies to where they are needed
- **WALL UNIT** – Ships complete with its own mounting bracket for easy installation
- **BENCH UNIT** – 2-piece base allows for assembly as a single- or double-sided unit
- **VARIETY** – Preconfigured packages with Stone AkroBins® are available, or create your own system using AkroBins and InSight® Bins!
- **FLEXIBILITY** – Louvered Panel Hooks are great for hanging tools, rolls of tape, hoses and tubing, therapy bands and more (see page 36)



A30536
Wall Unit



A98536
Bench Unit



A30553
Mobile Floor Unit
with Louvered Panel Hooks
(see page 36)



COLOR
White



ReadySpace Wall Unit Packages		Capacity/Qty.		
Model No.	Description (L x D x H)	No. of Ctns.	Wt. Cap. (lbs.)	Bin Qty.
A30536	37-1/2" x 1-3/4" x 25-3/8", Panel	1	50	N/A
A30536210S	Unit with A30210STONE Bins	3	50	48
A30536220S	Unit with A30220STONE Bins	3	50	48
A30536230S	Unit with A30230STONE Bins	3	50	24
A30536235S	Unit with A30235STONE Bins	3	50	12
A30536320S	Unit with A30320STONE Bins	2	50	4
A30536A1	ReadySpace Wall Unit with A305A1	4	50	48
A30536A3	ReadySpace Wall Unit with A305A3	4	50	48
A30536A5	ReadySpace Wall Unit with A305A5	5	50	48
A30536B1	ReadySpace Wall Unit with A305B1	3	50	24

ReadySpace Mobile Floor Unit Packages		Capacity/Qty.		
Model No.	Description (L x D x H)	No. of Ctns.	Wt. Cap. (lbs.)	Bin Qty.
A30553	24-5/8" x 23" x 52"	1	150	N/A
A30553210S	Unit with A30210STONE Bins	6	150	110
A30553220S	Unit with A30220STONE Bins	6	150	110
A30553230S	Unit with A30230STONE Bins	6	150	56
A30553235S	Unit with A30235STONE Bins	6	150	28
A30553A1	ReadySpace Mobile Floor Unit with A305A1	9	150	110
A30553A3	ReadySpace Mobile Floor Unit with A305A3	9	150	110
A30553A5	ReadySpace Mobile Floor Unit with A305A5	11	150	110
A30553B1	ReadySpace Mobile Floor Unit with 3A05B1	7	150	56
A30553LF	Leveling Feet for Floor Unit - 4 Pack	-	150	-

ReadySpace Bench Unit Packages		Capacity/Qty.		
Model No.	Description (L x D x H)	No. of Ctns.	Wt. Cap. (lbs.)	Bin Qty.
A98536	37-3/4" x 12" x 26-3/8" (Single)	1	100	N/A
A98536210SS	Single-Sided Bench Unit with A30210STONE Bins	3	100	48
A98536220SS	Single-Sided Bench Unit with A30220STONE Bins	3	100	48
A98536230SS	Single-Sided Bench Unit with A30230STONE Bins	3	100	24
A98536235SS	Single-Sided Bench Unit with A30235STONE Bins	3	100	12
A98536320SS	Single-Sided Bench Unit with A30320STONE Bins	2	100	4
A98536	37-3/4" x 22-1/2" x 26-3/8" (Double)	1	100	N/A
A98536210SD	Double-Sided Bench Unit with A30210STONE Bins	5	100	96
A98536220SD	Double-Sided Bench Unit with A30220STONE Bins	5	100	96
A98536230SD	Double-Sided Bench Unit with A30230STONE Bins	5	100	48
A98536235SD	Double-Sided Bench Unit with A30235STONE Bins	5	100	24
A98536320SD	Double-Sided Bench Unit with A30320STONE Bins	3	100	8

Lean Panel™ : Lean Floor Rack

ANGLED LOUVERED HANGING SYSTEM

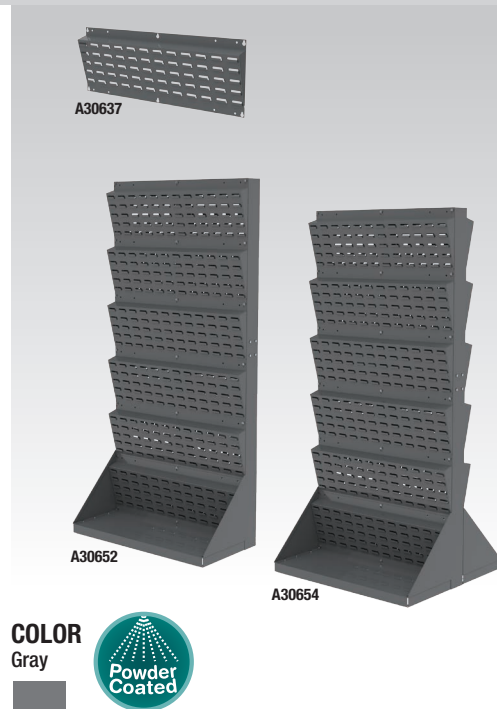
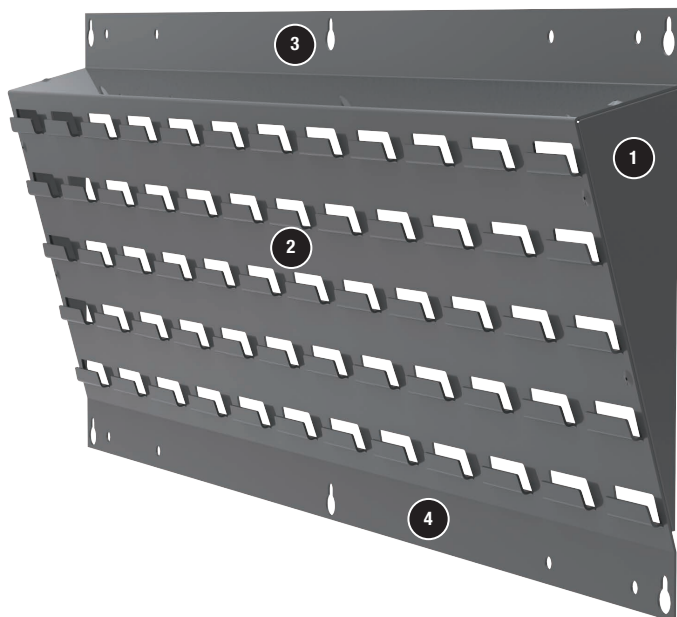

FEATURES



- 1 Keeps hanging bins at an ergonomic 15-degree angle for easier visibility and more comfortable picking
- 2 Louvers allow for easy placement of AkroBins® or InSight® Bins
- 3 Individual panels can be wall mounted or used with floor standing racks
- 4 Durable powder-coated finish on heavy-duty 16-gauge steel



Lean Panel & Lean Panel Floor Rack		Dimensions (In.)			
Model No.	Description	L	W	H	Weight Capacity
A30637A	Lean Panel – 1 PACK	35-1/2	2-1/2	13-1/4	90 lbs.
A30637	Lean Panel – 3 PACK	35-1/2	2-1/2	13-1/4	90 lbs. ea.
A30652	Single-Sided Floor Rack	35-3/4	17	75-1/8	500 lbs.
A30654	Double-Sided Floor Rack	35-3/4	32	75-1/8	1000 lbs.
A30653DOLLY	Mobile Kit for Floor Rack	–	–	–	500 lbs.

AkroBin Quantities for Lean Panel & Lean Panel Floor Rack

Model No.	A30210, A30220	A30224	A30230, A30234	A30239, A30240, A30265	A30235	A30237	A30260	A30255, A30265	A30250, A30270	A30320
A30637A	24	16	12	4	6	10	3	4	2	2
A30652	144	96	72	24	36	60	18	24	12	12
A30654	288	192	144	48	72	120	36	48	24	24



IMAGE INCLUDES:
 A30654 1
 A30653DOLLY 1
 A30220RED . . 16
 A30320BLUE . . 2
 A30230GREEN 12
 A30235YELLOW . 6
 A30255RED . . . 4
 A30234BLUE 12
 A30240GREEN 8
 A30260YELLOW . 6
 A30250RED . . . 4

A30654 with A30653DOLLY (Bins sold separately)

Pick Racks

HIGH-DENSITY STORAGE WITH ANGLED SHELVES



APRD162 with
APRMOBILE

MADE
IN THE
USA

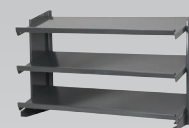

APRBENCH



APRS



APRD18

COLOR
Gray



FEATURES

- 16-gauge steel construction
- Angled shelves keep parts at the front of bin
- Works with Akro-Mils' industry-leading Shelf Bins, ShelfMax® Bins, Indicator® Bins, AkroDrawers® and System Bins™
- Durable, powder-coated finish

PRODUCT HIGHLIGHTS

- EFFICIENT** – Improve workspace organization and efficiency
- HEAVY-DUTY** – Up to 1,800 lb. capacity with Double-Sided 18" Racks; Bench Rack 100 lbs. per shelf
- VARIETY** – Choose from 3 styles: Single-Sided, Double-Sided, Bench, and two shelf depths: 12" and 18"

12" Deep Pick Rack 12" D x 36¾" W x 60¼" H				Shelf Dimensions (in.)		
Model No.	Description	Wt. Capacity (Lbs.)	Caster	D	L	H
APRS	Single-Sided Pick Rack (no bins)	400	–	12-1/8	35-5/8	6-7/16
APRD	Double-Sided Pick Rack (no bins)	800	–	12-1/8	35-5/8	6-7/16
APRMOBILE	Mobile Kit (Handle & Dolly) for Double-Sided Pick Rack	500	4" x 1½" Polyolefin	–	–	–

Bench Rack 12" D x 36¾" W x 25" H			Bin Dimensions (In.)			
Model No.	Description	Bin Model No.	L	W	H	Bin Qty.
APRBENCH	Bench Pick Rack, No Bins	–	–	–	–	–
APRBENCH120*	Bench Pick Rack with Shelf Bins	A30120	11-5/8	4-1/8	4	24
APRBENCH150*	Bench Pick Rack with Shelf Bins	A30150	11-5/8	8-3/8	4	12
APRBENCH040**	Bench Pick Rack with ShelfMax	A30040	11-5/8	4-1/8	6	24
APRBENCH090**	Bench Pick Rack with ShelfMax	A30090	11-5/8	6-5/8	6	15
APRBENCH010	Bench Pick Rack with ShelfMax	A30010	11-5/8	11-1/8	6	16‡
APRBENCH312	Bench Pick Rack with System Bins	A30312	12	33	5	3

*Specify color of Shelf Bins when ordering: Red, Blue, Yellow, Green or White. **Specify color of ShelfMax Bins when ordering: Red, Blue, Yellow or Crystal Clear. ‡Bonus bins included.

18" Deep Pick Rack 18" D x 36¾" W x 60¼" H				Shelf Dimensions (In.)		
Model No.	Description	Wt. Capacity (Lbs.)	Caster	D	L	H
APRS18	Single-Sided Pick Rack (no bins)	900*	–	18-1/8	35-5/8	6-7/16
APRD18	Double-Sided Pick Rack (no bins)	1800**	–	18-1/8	35-5/8	6-7/16
APRD18MOBILE	Mobile Kit (Handle & Dolly) for Double-Sided Pick Rack	1800	5" x 2" Phenolic	–	–	–

*When anchored to wall and floor. **When anchored to floor.

Pick Rack Systems

12" DEEP ANGLED SHELVES

Shelf Bins



APRS170G

ShelfMax Bins

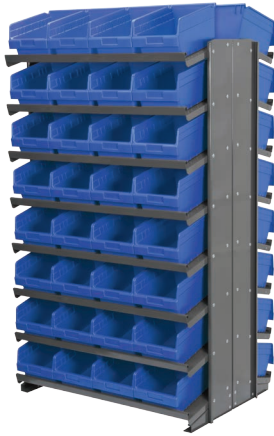

APRD080B

Indicator Bins

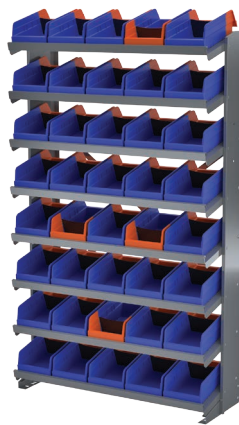

APRS36462B

AkroDrawer Bins



APRD182CRY

System Bins



APRD312R

12" Deep Single-Sided Pick Rack			Bin Dimensions (In.)				
Model No.	Description	Bin Model No.	L	W	H	Bin Qty.	Colors
Shelf Bins							
APRS110	Rack with Shelf Bins	A30110	11-5/8	2-3/4	4	96	B,R,Y,G,W,SC
APRS120	Rack with Shelf Bins	A30120	11-5/8	4-1/8	4	64‡	B,R,Y,G,W,SC
APRS130	Rack with Shelf Bins	A30130	11-5/8	6-5/8	4	40‡	B,R,Y,G,W,SC
APRS150	Rack with Shelf Bins	A30150	11-5/8	8-3/8	4	32‡	B,R,Y,G,W,SC
APRS170	Rack with Shelf Bins	A30170	11-5/8	11-1/8	4	24	B,R,Y,G,W,SC
ShelfMax Bins							
APRS040	Rack with ShelfMax	A30040	11-5/8	4-1/8	6	64	B,R,Y,SC
APRS080	Rack with ShelfMax	A30080	11-5/8	8-3/8	6	32	B,R,Y,SC
APRS090	Rack with ShelfMax	A30090	11-5/8	6-5/8	6	40	B,R,Y,SC
APRS010	Rack with ShelfMax	A30010	11-5/8	11-1/8	6	24	B,R,Y,SC
APRSAST00	Rack with ShelfMax	A30040 / A30090	See above			32 / 20	B,R,Y,SC
Indicator Bins							
APRS36442B	Rack with Indicator Bins	A36442BLUE	11-5/8	4-1/4	4	64‡	B
APRS36462B	Rack with Indicator Bins	A36462BLUE	11-5/8	6-3/4	4	40‡	B
AkroDrawers							
APRS112	Rack with AkroDrawers	A31112	11-5/8	11-1/8	4-5/8	24	B,R,Y,GRY,CRY
APRS142	Rack with AkroDrawers	A31142	11-5/8	3-3/4	4-5/8	72	B,R,Y,GRY,CRY
APRS162	Rack with AkroDrawers	A31162	11-5/8	5-9/16	4-5/8	48	B,R,Y,GRY,CRY
APRS182	Rack with AkroDrawers	A31182	11-5/8	8-3/8	4-5/8	32	B,R,Y,GRY,CRY
APRSAST	Rack with AkroDrawers	A31142, A31162, A31182	See Above			18 / 24 / 8	B,R,Y,GRY,CRY
System Bins							
APRS312	Rack with System Bins	A30312	12	33	5	8‡	B,R,Y

Specify color of bins when ordering. ‡Bonus bins included. B=Blue, R=Red, Y=Yellow, G=Green, W=White, SC=Clear, GRY=Gray, CRY=Crystal Clear.

12" Deep Double-Sided Pick Rack			Bin Dimensions (In.)				
Model No.	Description	Bin Model No.	L	W	H	Bin Qty.	Colors
Shelf Bins							
APRD110	Rack with Shelf Bins	A30110	11-5/8	2-3/4	4	192	B,R,Y,G,W,SC
APRD120	Rack with Shelf Bins	A30120	11-5/8	4-1/8	4	128‡	B,R,Y,G,W,SC
APRD130	Rack with Shelf Bins	A30130	11-5/8	6-5/8	4	80‡	B,R,Y,G,W,SC
APRD150	Rack with Shelf Bins	A30150	11-5/8	8-3/8	4	64‡	B,R,Y,G,W,SC
APRD170	Rack with Shelf Bins	A30170	11-5/8	11-1/8	4	48	B,R,Y,G,W,SC
ShelfMax Bins							
APRD040	Rack with ShelfMax	A30040	11-5/8	4-1/8	6	128	B,R,Y,SC
APRD080	Rack with ShelfMax	A30080	11-5/8	8-3/8	6	64	B,R,Y,SC
APRD090	Rack with ShelfMax	A30090	11-5/8	6-5/8	6	80	B,R,Y,SC
APRD010	Rack with ShelfMax	A30010	11-5/8	11-1/8	6	48	B,R,Y,SC
APRDAST00	Rack with ShelfMax	A30040 / A30090	See above			64 / 40	B,R,Y,SC
Indicator Bins							
APRD36442B	Rack with Indicator Bins	A36442BLUE	11-5/8	4-1/4	4	128‡	B
APRD36462B	Rack with Indicator Bins	A36462BLUE	11-5/8	6-3/4	4	80‡	B
AkroDrawers							
APRD112	Rack with AkroDrawers	A31112	11-5/8	11-1/8	4-5/8	48	B,R,Y,GRY,CRY
APRD142	Rack with AkroDrawers	A31142	11-5/8	3-3/4	4-5/8	144	B,R,Y,GRY,CRY
APRD162	Rack with AkroDrawers	A31162	11-5/8	5-9/16	4-5/8	96	B,R,Y,GRY,CRY
APRD182	Rack with AkroDrawers	A31182	11-5/8	8-3/8	4-5/8	64	B,R,Y,GRY,CRY
APRDAST	Rack with AkroDrawers	A31142, A31162, A31182	See Above			36 / 48 / 16	B,R,Y,GRY,CRY
System Bins							
APRD312	Rack with System Bins	A30312	12	33	5	16‡	B,R,Y

Specify color of bins when ordering. ‡Bonus bins included. B=Blue, R=Red, Y=Yellow, G=Green, W=White, SC=Clear, GRY=Gray, CRY=Crystal Clear.

Pick Rack Systems

18" DEEP ANGLED SHELVES

Shelf Bins



APRS18128G

ShelfMax Bins

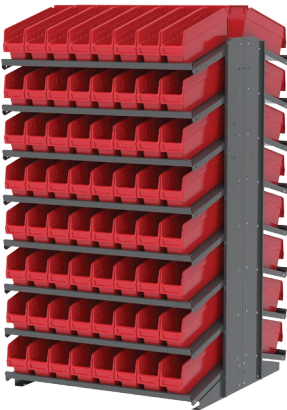

APRD18048R

Indicator Bins

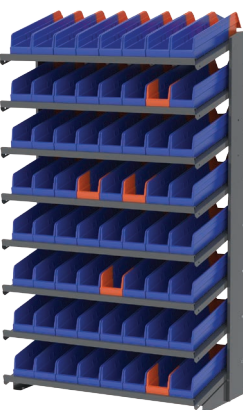

APRS1836448B

AkroDrawer Bins



APRD18148B

System Bins

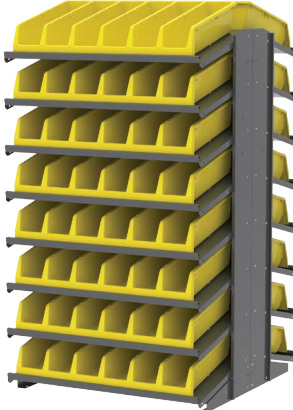

APRD18318Y

18" Deep Single-Sided Pick Rack			Bin Dimensions (In.)				
Model No.	Description	Bin Model No.	L	W	H	Bin Qty.	Colors
Shelf Bins							
APRS18128	Rack with Shelf Bins	A30128	17-7/8	4-1/8	4	72‡	B,R,Y,G,W,SC
APRS18138	Rack with Shelf Bins	A30138	17-7/8	6-5/8	4	48‡	B,R,Y,G,W,SC
APRS18158	Rack with Shelf Bins	A30158	17-7/8	8-3/8	4	36‡	B,R,Y,G,W,SC
APRS18178	Rack with Shelf Bins	A30178	17-7/8	11-1/8	4	24	B,R,Y,G,W,SC
ShelfMax Bins							
APRS18048	Rack with ShelfMax	A30048	17-7/8	4-1/8	6	64	B,R,Y,SC
APRS18088	Rack with ShelfMax	A30088	17-7/8	8-3/8	6	32	B,R,Y,SC
APRS18098	Rack with ShelfMax	A30098	17-7/8	6-5/8	6	40	B,R,Y,SC
APRS18018	Rack with ShelfMax	A30018	17-7/8	11-1/8	6	24	B,R,Y,SC
APRS18AST00	Rack with ShelfMax	A30048 / A30098	See above			32/20	B,R,Y,SC
Indicator Bins							
APRS1836448	Rack with Indicator Bins	A36448BLUE	17-7/8	4-1/8	4	72‡	B
APRS1836468	Rack with Indicator Bins	A36468BLUE	17-7/8	6-5/8	4	48‡	B
AkroDrawers							
APRS18148	Rack with AkroDrawers	A31148	17-5/8	3-3/4	4-5/8	72	B,R,Y,GRY,CRY
APRS18168	Rack with AkroDrawers	A31168	17-5/8	5-9/16	4-5/8	48	B,R,Y,GRY,CRY
APRS18188	Rack with AkroDrawers	A31188	17-5/8	8-3/8	4-5/8	32	B,R,Y,GRY,CRY
APRS18118	Rack with AkroDrawers	A31118	17-5/8	11-1/8	4-5/8	24	B,R,Y,GRY,CRY
System Bins							
APRS18318	Rack with System Bins	A30318	18	33	5	8‡	B,R,Y

Specify color of bins when ordering. ‡Bonus bins included. B=Blue, R=Red, Y=Yellow, G=Green, W=White, SC=Clear, GRY=Gray CRY=Crystal Clear.

18" Deep Double-Sided Pick Rack			Bin Dimensions (In.)				
Model No.	Description	Bin Model No.	L	W	H	Bin Qty.	Colors
Shelf Bins							
APRD18128	Rack with Shelf Bins	A30128	17-7/8	4-1/8	4	132‡	B,R,Y,G,W,SC
APRD18138	Rack with Shelf Bins	A30138	17-7/8	6-5/8	4	84‡	B,R,Y,G,W,SC
APRD18158	Rack with Shelf Bins	A30158	17-7/8	8-3/8	4	72‡	B,R,Y,G,W,SC
APRD18178	Rack with Shelf Bins	A30178	17-7/8	11-1/8	4	48	B,R,Y,G,W,SC
ShelfMax Bins							
APRD18048	Rack with ShelfMax	A30048	17-7/8	4-1/8	6	128	B,R,Y,SC
APRD18088	Rack with ShelfMax	A30088	17-7/8	8-3/8	6	64	B,R,Y,SC
APRD18098	Rack with ShelfMax	A30098	17-7/8	6-5/8	6	80	B,R,Y,SC
APRD18018	Rack with ShelfMax	A30018	17-7/8	11-1/8	6	48	B,R,Y,SC
APRD18AST00	Rack with ShelfMax	A30048 / A30098	See above			64/40	B,R,Y,SC
Indicator Bins							
APRD1836448	Rack with Indicator Bins	A36448BLUE	17-7/8	4-1/8	4	132‡	B
APRD1836468	Rack with Indicator Bins	A36468BLUE	17-7/8	6-5/8	4	84‡	B
AkroDrawers							
APRD18148	Rack with AkroDrawers	A31148	17-5/8	3-3/4	4-5/8	144	B,R,Y,GRY,CRY
APRD18168	Rack with AkroDrawers	A31168	17-5/8	5-9/16	4-5/8	96	B,R,Y,GRY,CRY
APRD18188	Rack with AkroDrawers	A31188	17-5/8	8-3/8	4-5/8	64	B,R,Y,GRY,CRY
APRD18118	Rack with AkroDrawers	A31118	17-5/8	11-1/8	4-5/8	48	B,R,Y,GRY,CRY
System Bins							
APRD18318	Rack with System Bins	A30318	18	33	5	16‡	B,R,Y

Specify color of bins when ordering. ‡Bonus bins included. B=Blue, R=Red, Y=Yellow, G=Green, W=White, SC=Clear, GRY=Gray CRY=Crystal Clear.

Storage Cases : Utility Boxes : Portable Organizers

CUSTOMIZABLE, LIGHTWEIGHT, PORTABLE BOXES



Clear Storage Cases

GRIDDED LID KEEPS ITEMS IN PLACE

FEATURES

- 1 Grid design in lid keeps items from spilling into other compartments
- 2 Dividers are adjustable for customized storage

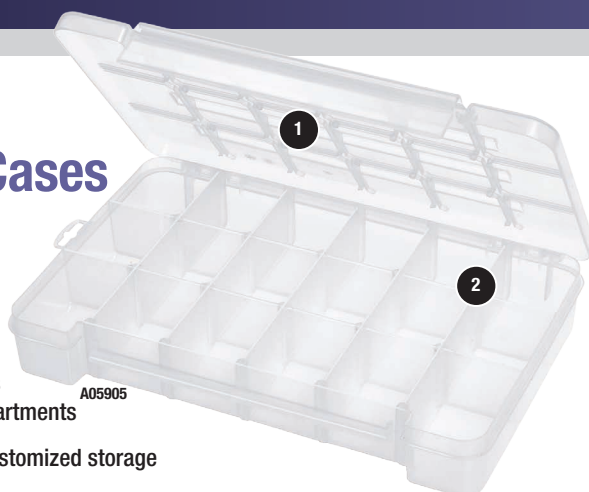

MADE IN THE USA

PRODUCT HIGHLIGHTS

- **FUNCTIONAL** – Plastic storage cases are ideal in any setting for parts storage
- **ADJUSTABLE** – Cases include front-to-back adjustable dividers
- **DURABLE** – Molded of clear industrial-grade polymers

Storage Cases		Dimensions (In.)			Capacity/Qty.	
Model No.	Description	L	W	H	Maximum Compartments	Ctn. Qty.
A05705	Small Case – 2 Fixed Dividers; 4 Adjustable Dividers	8-5/8	5-1/8	1-5/8	15	12
A05805	Medium Case – 2 Fixed Dividers; 4 Adjustable Dividers	11	7	2-3/8	15	6
A05905	Large Case – 2 Fixed Dividers; 5 Adjustable Dividers	14-3/8	9-1/2	2-1/2	18	6

Order in carton quantities.

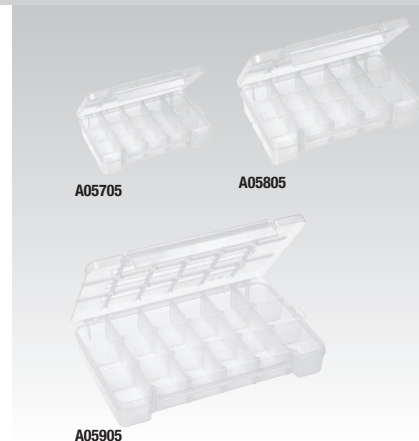

COLOR
Clear



Small & Medium Cases

2 Fixed Dividers
4 Adjustable Dividers

Large Cases

2 Fixed Dividers
5 Adjustable Dividers

Utility Boxes

- **VERSATILE** – Perfect for kits
- **ADJUSTABLE** – Includes 2 adjustable dividers
- **FLAT LID** – For easy labeling of case contents

COLOR
Clear



Utility Boxes		Dimensions (In.)			Capacity/Qty.	
Model No.	Description	L	W	H	Maximum Compartments	Ctn. Qty.
A96352A	Medium Utility Box – 5 Fixed Dividers	8-5/16	4-5/8	1-1/2	18	12
A96352B	Large Utility Box – 4 Fixed Dividers	11	6-3/8	2-1/2	15	6

Order in carton quantities.



MADE IN THE USA

Portable Organizers

- **FUNCTIONAL** – Unique design keeps parts from migrating to other compartments when the lid is shut
- **DIVIDABLE** – Adjustable dividers included for customized storage in both levels

COLOR
Blue/Clear



Portable Organizers		Dimensions (In.)			Capacity/Qty.	
Model No.	Description	L	W	H	Maximum Compartments	Ctn. Qty.
A06115	Lid Storage Organizer	15	11-5/16	3-1/4	11 to 46	1
A06118	Large Lid Storage Organizer	18-1/4	13-1/2	3-3/4	12 to 62	1

Order in carton quantities.



MADE IN THE USA

Roto-Shelf : Tote Caddy : ProBox™ Toolboxes

SMALL PARTS STORAGE



MADE IN THE USA

Roto-Shelf

- **MOBILE** – Roto-Shelf can be moved easily to different work areas; ideal for assembly components
- **FUNCTIONAL** – 24 individual storage compartments
- **COMPACT** – 19⁷/₈" wide unit takes up little floor space
- **ROTATING** – 3 shelves rotate on an independent central metal shaft
- **CAPACITY** – 75 lbs. per shelf, 300 lbs. total capacity

COLOR
Black/Red



Roto-Shelf		Dimensions (In.)			
Model No.	Description	D	H	Caster	Ctn. Qty.
A02420	Roto-Shelf	19-7/8	37-1/2	3" Polyurethane	1



MADE IN THE USA

AVAILABLE IN CLEAR



Tote Caddy

- **COMPACT** – Hand-held tool and supply caddy
- **FUNCTIONAL** – Deep compartments hold loose parts, cleaning supplies or tools for easy transport; two shallow compartments are perfect for hardware, keys or loose items
- **DURABLE** – Molded of heavy-duty, industrial-grade polymers with a textured finish for lasting durability

COLORS
Blue, Clear



Tote Caddy		Dimensions (In.)			
Model No.	Description	L	W	H	Ctn. Qty.
A09185BLUE	Tote Caddy - Blue	13-7/8	18-3/8	9	6
A091855CLAR	Tote Caddy - Clear	13-7/8	18-3/8	9	6

Order in carton quantities.



A09514

MADE IN THE USA

A09912

ProBox™ Toolboxes

- **FUNCTIONAL** – 14" unit includes removable tool tray and metal latch*
- **SECURE** – 14" unit features oversized padlock eye

COLOR
Red



ProBox Toolbox		Dimensions (In.)			
Model No.	Description	L	W	H	Ctn. Qty.
A09912*	12" ProBox	12	6	4	12
A09514	14" ProBox	14	8-1/8	8-1/8	6

Order in carton quantities. *12" unit does not include tray.

TiltView®

TILTING BINS OFFER VISIBLE, DUST-FREE STORAGE



FEATURES

- 1 Cabinets made of high-impact polystyrene
- 2 Bins made of polystyrene (GPS)
- 3 Molded-in label holder (card stock labels included)
- 4 Neutral Stone color is ideal for any environment
- 5 A06702 slides apart to form two separate bins

PRODUCT HIGHLIGHTS

- **EFFICIENT** – Space-saving system will improve organization and efficiency in a variety of settings, including medical and pharmacy!
- **FUNCTIONAL** – Can be used on a desktop, attached to steel rails, frames or louvered panels, and are wall mountable
- **VARIETY** – Available in 6 sizes



A06702



A06703



A06704



A06705



A06706



A06709

COLOR
Stone



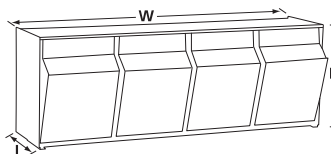

TiltView Bins		Dimensions (In.)			Capacity/Qty.		Accessories	
Model No.	Description	L	W	H	Ctn. Qty.	Capacity Lbs.	Dividers	Replacement Cups
A06702	2-Bin TiltView	12-5/16	23-5/8	14	1	30	–	A06702CUP
A06703	3-Bin TiltView	7-7/8	23-5/8	9-7/16	1	30	A40703 (3/Pk)	A06703CUP
A06704	4-Bin TiltView	6-3/4	23-5/8	8-3/16	1	25	A40704 (4/Pk)	A06704CUP
A06705	5-Bin TiltView	5-3/8	23-5/8	6-1/2	1	20	–	A06705CUP
A06706	6-Bin TiltView	3-3/4	23-5/8	4-1/2	1	15	–	A06706CUP
A06709	9-Bin TiltView	2-1/2	23-5/8	3-3/16	1	5	–	A06709CUP

TiltView Accessories		
Model No.	Description	Ctn. Qty.
TVHDWR	TiltView Hardware Pack (need 1 set per unit)	1 Set
TVLRA	TiltView Locking Rod	2 Pk.
TVLR	TiltView Locking Rod	12 Pk.
TVCLIP	TiltView Hanging Clip	2 Pk.

TiltView Rails		Dimensions (In.)			Number of Bins to Fit Each Rail Set					
Model No.	Description	L	W	H	A06702	A06703	A06704	A06705	A06706	A06709
TV24R	24" TiltView Rails	1-1/8	1-3/8	24-1/8	1	2	3	3	5	8
TV48R	48" TiltView Rails	1-1/8	1-3/8	48-1/8	3	5	6	7	10	16
TV70R	70" TiltView Rails	1-1/8	1-3/8	70-1/8	5	7	8	10	15	23

One Rail Set = 2 Rails. Bins sold separately; mounting bins requires hardware pack.

TiltView Frames		Dimensions (In.)			Number of Bins to Fit Each Frame					
Model No.	Description	L	W	H	A06702	A06703	A06704	A06705	A06706	A06709
TV24F	24" TiltView Frames	1-1/8	13-1/4	24-1/8	1	2	3	3	5	8
TV48F	48" TiltView Frames	1-1/8	13-1/4	48-1/8	3	5	6	7	10	16
TV70F	70" TiltView Frames	1-1/8	13-1/4	70-1/8	5	7	8	10	15	23

Bins sold separately; mounting bins requires hardware pack.

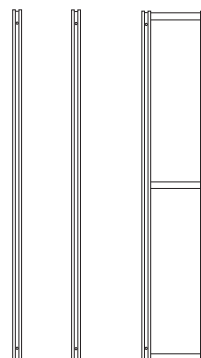

ACCESSORIES



Dividers
Optional dividers (for 3-Bin and 4-Bin models) expand sorting options



Wall Mount Frames
16-gauge steel frames make a system where bin units are easily stacked and removed securely



Locking Rod
Model No. TVLR
Keeps contents secure; rods easily attach to unit, and flip down to keep the bins from opening



Rail Systems
16-gauge steel rails convert bins into customizable hanging wall systems



TiltView Clips
Model No. TVCLIP
Allow easy attachment to Akro-Mils' Louvered Hanging Systems or the ReadySpace® Storage System

RELATED PRODUCTS

Using the TiltView Clips, bins will attach to the following products



33 Rail Hanging Systems



34-39 Louvered Hanging Systems



39 ReadySpace Storage System



54 Heavy-Duty Cabinet Systems



54 Quick-View Cabinet Systems

Steel Storage Cabinets

17-SERIES & 19-SERIES



19-Series Cabinets

HEAVY-DUTY VERSATILE CABINET

FEATURES

- 1 Chip-proof, durable powder-coated finish
- 2 Heavy-duty 24-gauge, welded-steel frame for strength
- 3 Built-in nesting feet for safe, stable stacking
- 4 Label holder and transparent window for content identification
- 5 Industrial-grade plastic drawers available in 5 colors!
- 6 Dovetail dividers lock securely in place and provide up to 8 compartments

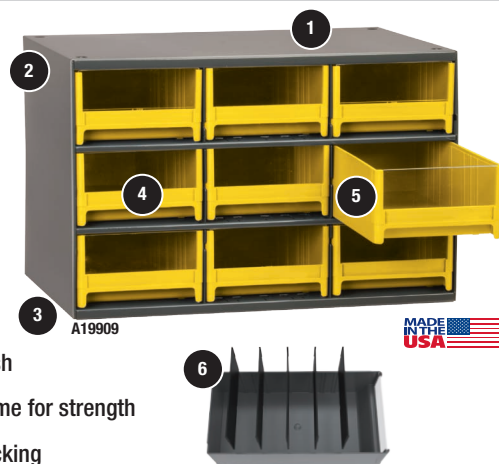

A19909

MADE IN THE USA

PRODUCT HIGHLIGHTS

- **FUNCTIONAL** – The perfect choice for easy access and organization of small parts. Cabinet size: 17" wide x 11" deep x 11" high. Drawer depth: 10⁹/₁₆"
- **SAFE** – No sharp edges to damage parts. Unique rear stop tab on each drawer prevents spills
- **EXPANDABLE** – Cabinets can be used with Rail Racks, ProCart™, Storage-Go-Round, or Louvered Panels with optional Suspension Straps
- **WALL-MOUNTABLE** – 4 "keyhole slots" on back for easy wall mounting
- **VARIETY** – Available in 5 models and 5 drawer colors: Red, Blue, Yellow, Gray and Black. Cabinet with locking door also available!

19-Series Heavy-Duty Steel Cabinets			Drawer Dimensions (In.)			Accessories		
Model No.	Description	Drawers Per Cabinet‡	W	H	D	Ctn. Qty.	Drawer Model No.	Dividers 25/Pkg. Model No.
A19228	Steel Storage Cabinet	28	2-3/16	2-1/16	10-9/16	1	A20228	A40228
A19320	Steel Storage Cabinet	20	3-3/16	2-1/16	10-9/16	1	A20320	A40320
A19416	Steel Storage Cabinet	16	4	2-1/8	10-9/16	1	A20416	A40416
A19715	Steel Storage Cabinet	15	3-3/16	3-1/16	10-9/16	1	A20715	A40715
A19909	Steel Storage Cabinet	9	5-3/16	3-1/16	10-9/16	1	A20909	A40909
A19109	Storage Cabinet w/ Locking Door	9	5-3/16	3-1/16	10-9/16	1	A20909	A40909
A98400	Suspension Straps (Set of 2)	-	-	-	-	12 sets	-	-

One drawer color per cabinet. Specify Red, Blue, Yellow, Gray or Black when ordering. ‡ Two removable dividers and one label per drawer included.

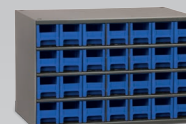

A19228

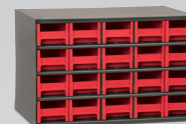

A19320

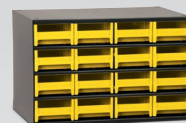

A19416



A19715



A19909



A19109

Lockable Door!

DRAWER COLORS

Red, Yellow, Blue, Gray, Black



CABINET COLOR

Gray



17-Series Cabinet

ECONOMICAL STEEL FRAME CABINET

- **STEEL FRAME** – 18" wide x 6" deep x 9¹/₂" high
- **CRYSTAL CLEAR DRAWERS** – Rust, corrosion and dent-proof

17-Series Light-Duty Steel Cabinets			Drawer Dimensions (In.)			Accessories		
Model No.	Description	Drawers Per Cabinet‡	W	H	D	Ctn. Qty.	Drawer Model No.	Dividers 25/Pkg. Model No.
A17018	Storage Cabinet	18	2-3/4	2-1/2	5-3/4	1	A20902	A40901

‡ One removable divider per drawer included.

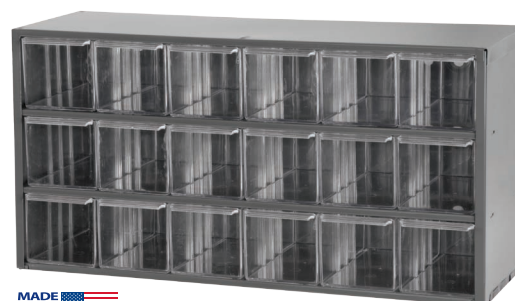

MADE IN THE USA

Storage-Go-Round : Mobile Steel Cabinet Rack

HIGH-DENSITY STORAGE OPTIONS



Storage-Go-Round

1,000 LBS. OF PARTS IN 1 SQUARE YARD

FEATURES

- 1 Securely holds (20) 19-Series cabinets, sold separately
- 2 Small workspace footprint: compact swing diameter 43⁵/₈"
- 3 Ball-transfer base rotates for easy access to parts
- 4 Durable, powder-coated finish
- 5 Mix or match color options and drawer sizes to take organization to the next level!

PRODUCT HIGHLIGHTS

- **EFFICIENT** – Streamlines workflow and order picking
- **DUST-FREE** – Cabinets and drawers minimize dust collection
- **CAPACITY** – Holds 20 steel cabinets; weight capacity of 1,000 lbs.
- **VARIETY** – Mix or match steel cabinet drawer colors: Red, Blue, Yellow, Gray, Black

Storage-Go-Round		Assembled Dimensions (In.)			Compatible with Models*	COLOR Gray
Model No.	Description	L	W	H		
A98325	Storage-Go-Round with turntable base	31	31	60	A19228, A19320, A19416, A19715, A19909	

Assembly required. * 19-Series Cabinets sold separately.



Mobile Steel Cabinet Rack

500 LBS. OF PARTS WITHIN REACH

- **VERSATILE** – Double-sided, mobile rail rack holds up to 12 cabinets, with as many as 336 drawers
- **HEAVY-DUTY** – Supports up to 500 lbs.

COLOR
Gray



Mobile Steel Cabinet Rack		
Model No.	Description	Required Components Qty.
A30016	Double-Sided Rail Rack – 36" W x 24" D x 57" H	1 each
A30424	Mobile Kit	1 each
A98400	Suspension Straps (Set of 2) ††	12 sets

Assembly required. See chart above. †† A98400 suspension straps required for hanging. Two straps per cabinet needed to secure cabinets to rack. Mix/match 12 19-Series Cabinets.

ACCESSORIES

Suspension Straps
Model No A98400
Hang 19-Series Cabinets
securely to rail rack



Plastic Storage Cabinets

ORGANIZE & PROTECT HARDWARE & OFFICE SMALL PARTS



A10126

FEATURES

- 1 Cabinets made of rugged, high-impact plastic
- 2 Clear industrial-grade plastic drawers are unbreakable
- 3 Interlocking cabinet frame and face ensure strength and durability



PRODUCT HIGHLIGHTS

- **RECYCLED** – Cabinet frames are made of 100% recycled material. Make a positive impact on the environment!
- **VERSATILE** – Use Hanging Brackets to consolidate cabinets together on vertical storage panels and racks
- **STACKBLE** – Cabinets stack for more storage options
- **WALL-MOUNTABLE** – 4 “keyhole slots” on back for easy wall mounting
- **DIVIDABLE** – A limited number of drawer dividers provided. Additional dividers sold separately
- **VARIETY** – Available in 5 models

Plastic Storage Cabinets		Drawer Qty.		Dimensions (In.)			Ctn. Qty.
Model No.	Description	Large A20702	Small A20701	L	W	H	
A10116	16-Drawer Cabinet	0	16	10-1/2	6-3/8	8-1/2	1
A10124	24-Drawer Cabinet	24	0	20	6-3/8	15-13/16	1
A10126	26-Drawer Cabinet	6	20	20	6-3/8	10-1/4	1
A10144	44-Drawer Cabinet	12	32	20	6-3/8	15-13/16	1
A10164	64-Drawer Cabinet	0	64	20	6-3/8	15-13/16	1

16-Drawer Cabinet has 8 dividers. All other cabinets have 8 small and 4 large dividers.

Additional Dividers (Plastic Cabinets)	
Model No.	Description
A40716	16-Pack additional dividers for small drawers
A40717	6-Pack additional dividers for large drawers

10-Series Plastic Cabinet Hanging Bracket		Capacity/Qty.	
Model No.	Description	Wt. Cap. (lbs.)	Pkg. Qty.
A98100	Large Hanging Bracket for A10164, A10144, A10126, A10124	40	1
A98101	Small Hanging Bracket for A10116	20	1

ACCESSORIES



Hanging Bracket
Hang cabinets on Louvered Panels or Rail Racks



A20702 Large Drawer:
Outside Dimensions: 6" x 4½" x 2½"
Inside Dimensions: 4¾" x 4¼" x 2¼"



A20701 Small Drawer:
Outside Dimensions: 6" x 2¼" x 1½"
Inside Dimensions: 5¼" x 1¼" x 1¼"



A10116



A10124



A10126



A10144



A10164

COLOR

Black



Ready-To-Assemble Cabinet : Heavy-Duty Cabinets

SPECIALTY STORAGE CABINETS OFFER EVEN MORE OPTIONS

Ready-To-Assemble Bin Cabinet

SHIPS FLAT TO SAVE MONEY



UP TO 1000 LBS.

FEATURES

- 1 Cabinets made of 18-gauge steel with powder-coated finish
- 2 Louvered back wall panel
- 3 Flush mount handle with 3-point locking system
- 4 100-lb. capacity shelves adjust every 2"
- 5 Leveling feet



Optional Accessories		Dimensions (In.)			Weight Capacity
Model No.	Description	W	D	H	
AC3618RT	Rooftop	36	17-1/2	4-3/4	-
AC3618SHELF1PK	Extra Shelf	36	13	2-1/4	100 lbs.
AC803618M26	Cabinet Dolly	36-1/2	18-1/2	5-1/4	1000 lbs.
ACKEY	Replacement Key. The key is stamped 1333				

Ready-To-Assemble Bin Cabinet 36" W x 19" D x 78" H			
Model No.	Description	Bin Model No.	Qty. of Bins
AC3618KD4AS	Ready-to-Assemble Cabinet with 4 Adjustable Shelves	-	-
AC3618KD1ASY	Ready-to-Assemble Cabinet with 1 Adjustable Shelf, 30 AkroBins	A30230YELLO	12
		A30240YELLO	12
		A30250YELLO	6

AkroBin Model No.	L	W	H
A30230	10-7/8	5-1/2	5
A30240	14-3/4	8-1/4	7
A30250	14-3/4	16-1/2	7

ACCESSORIES



Rooftop
Prevents potentially hazardous items from being stored on top of the cabinet

Heavy-Duty Bin Cabinets

ALL-WELDED CONSTRUCTION

PRODUCT HIGHLIGHTS

- **STURDY** – All-welded 16-gauge steel construction with 7-gauge reinforced corners
- **SECURE** – Heavy-duty steel padlock-ready handle ensures complete security
- **ADJUSTABLE** – Shelves on 2" centers allowing the flexibility of securely storing multiple-sized objects
- **DURABLE** – Powder-coated paint is resistant to cuts and scratches

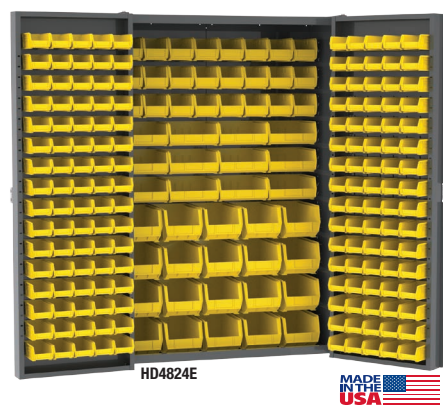

Heavy-Duty Cabinet 48" W x 24" D x 72" H			Wt. Capacity (Lbs.)	AkroBin Model No.	L	W	H
Model No.	Description	Bin Model No. / Qty. of Bins	Total/Door/Shelf				
HD4824A	Cabinet w/ Shelves Only, Deep Pocket Doors	-	2000 / 250 / 300	A30220	7-3/8	4-1/8	3
HD4824E	Cabinet w/ Louvered Panels on Back Wall & Doors, with Yellow AkroBins	160 - A30220YELLO; 24 - A30230YELLO; 20 - A30240YELLO; 12 - A30235YELLO	1500 / 250 / -	A30230	10-7/8	5-1/2	5
				A30235	10-7/8	11	5
				A30240	14-3/4	8-1/4	7
HD4824F	Cabinet w/ Louvered Panels on Back Wall & Doors, with Yellow AkroBins	160 - A30220YELLO; 48 - A30230YELLO; 20 - A30240YELLO	1500 / 250 / -	A30250	14-3/4	16-1/2	7
HD4824MCLAR	Cabinet w/ Louvered Panels on Back Wall & Doors, with Clear AkroBins	8 - A30240SCLAR*; 16 - A30250SCLAR*	1500 / 250 / -				

*Bonus Bins Included.



Padlock-ready handle

Model No. HD4824A
Louvered back wall, cabinet shelves, 4" deep pocket door shelves (no louvers)

Model No. HD4824E
Louvered back wall, louvered doors, bins. Includes 216 assorted Yellow AkroBins

Model No. HD4824F
Louvered back wall, louvered doors, bins. Includes 228 assorted Yellow AkroBins

Model No. HD4824MCLAR
Louvered back wall, louvered doors, bins. Includes 24 assorted Clear AkroBins

COLOR
Gray

Standard Bin Cabinets

ALL-WELDED SOLID DOOR BIN STORAGE CABINETS



AC3624YD3AS

UP TO 1500 LBS.



FEATURES

- 1 All-welded cabinets made of 16-gauge steel
- 2 Adjustable shelves hold up to 300 lbs. each
- 3 Louvered back wall panel
- 4 Keyed handle with 3-point locking system. 2 keys included. Replacement keys available, see chart



AkroBin Cabinet 36" W x 24" D x 78" H		
Model No.	Description	Bin Model No.
AC3624	Cabinet w/ Louvered Panels on Back & Doors, no Bins	-
AC3624Y	Cabinet w/ Louvered Panels on Back & Doors with Assorted AkroBins	A30210YELLO - 48; A30220YELLO - 48; A30230YELLO - 24; A30240YELLO - 12; A30250YELLO - 6
AC3624YD	Cabinet w/ Louvered Panels on Back & Doors with Assorted AkroBins	A30232YELLO - 16; A30242YELLO - 16; A30230YELLO - 24; A30240YELLO - 12; A30250YELLO - 6

Available in Putty, to order add PUT to the model number.

AkroBin Cabinet 36" W x 24" D x 78" H		
Model No.	Description	Bin Model No.
AC36243AS	Cabinet w/ 3 Shelves, Louvered Panels on Back & Doors, no Bins	-
AC3624Y3AS	Cabinet w/ 3 Shelves, Louvered Panels on Back & Doors, with Assorted AkroBins	A30210YELLO - 48; A30220YELLO - 48; A30250YELLO - 6
AC3624YD3AS	Cabinet w/ 3 Shelves, Louvered Panels on Back & Doors, with Assorted AkroBins	A30232YELLO - 16; A30242YELLO - 16; A30250YELLO - 6

Available in Putty, to order add PUT to the model number.

AkroBin Cabinet 36" W x 24" D x 78" H		
Model No.	Description	Bin Model No.
AC3618	Cabinet w/ Louvered Panels on Back Wall, no Bins	-
AC3618Y	Cabinet w/ Louvered Panels on Back Wall, with Assorted AkroBins	A30230YELLO - 24; A30240YELLO - 12; A30250YELLO - 6

Available in Putty, to order add PUT to the model number.

AkroBin Model No.	L	W	H
A30210	5-3/8	4-1/8	3
A30220	7-3/8	4-1/8	3
A30230	10-7/8	5-1/2	5
A30232	5-3/8	11	3
A30240	14-3/4	8-1/4	7
A30242	7-3/8	11	3
A30250	14-3/4	16-1/2	7

AkroBin® Cabinet
Model No. AC3624Y
Louvered panels on back wall and doors. 138 bins.
Weight capacity 1,200 lbs.



AkroBin® Cabinet
Model No. AC3624YD
Louvered panels on back wall and doors. 74 bins.
Weight capacity 1,200 lbs.



AkroBin Cabinet with 3 Shelves
Model No. AC3624Y3AS
Louvered panels and 3 full 24" shelves. 102 bins.
Weight capacity 1,500 lbs.

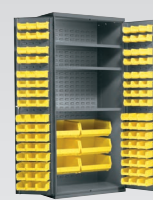

AkroBin Cabinet with 3 Shelves
Model No. AC3624YD3AS
Louvered panels and 3 full 24" shelves. 38 bins.
Weight capacity 1,500 lbs.



AkroBin Cabinet with Flush Doors
Model No. AC3618Y
Louvered panel on back wall. 42 bins.
Weight capacity 1,000 lbs.



Bin Cabinet Dolly
Model No. AC803624M26
Convert Standard Cabinets to mobile units!



COLOR
Gray, Putty



Bin Cabinet Dollies		Dimensions (In.)				
Model No.	Description	L	W	H	Polyolefin Casters	Weight Capacity
AC803618M26	18 x 36 Bin Cabinet Dolly	36-1/2	18-1/2	5-1/4	3 x 1-1/4"	1000 lbs.
AC803624M26	24 x 36 Bin Cabinet Dolly	36-1/2	24-1/2	6-1/2	4 x 1-1/4"	1000 lbs.

Standard Bin Cabinet Replacement Parts	
Model No.	Description
ACKEYF	Keys for AC Cabinets built after 9/2013. Stamped FH333.
ACKEY	Keys for Mini-Cabinet and the Ready-to-Assemble Cabinet; and for AC cabinets prior to 9/2013. Stamped 1333.
AC3618SHELF1PK	Gray 18" shelf
AC3618SHELF4PK	4-pack Gray 18" shelf
AC3624SHELF3PUT	3-pack Putty 24" shelf

Standard Bin Cabinets

ALL-WELDED BIN CABINETS WITH SECURE, VIEWABLE STORAGE

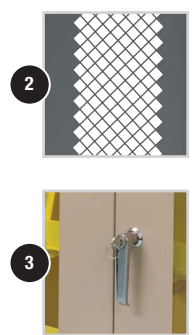

Quick-View Security Bin Cabinet
Model No. AC3618QV240
Lexan™ door panels; louvered back wall panel. Complete with 36 AkroBins. Comes standard in beige. Weight capacity 1,000 lbs.



Secure-View Security Bin Cabinet
Model No. AC3618SV240
Steel mesh door panels; louvered back wall panel. Complete with 36 AkroBins. Weight capacity 1,000 lbs.



Bin Cabinet Dolly
Model No. AC803618M26
Convert large cabinets to mobile units!

FEATURES

- 1 Durable, lightweight Lexan™ door panels keep out dust and debris (Quick-View)
- 2 Steel mesh door panels provide security and ventilation (Secure-View)
- 3 Keyed handle with 3-point locking system. 2 keys included. Replacement keys available, see chart on page 52

COLORS
Gray, Beige



Quick-View Security Bin Cabinet 36" W x 18" D x 78" H			
Model No.	Description	Bin Model No.	Qty. of Bins
AC3618QV	Beige Cabinet w/ Quick View Doors, Louvered Back, no Bins	-	-
AC3618QV240	Beige Cabinet w/ Quick View Doors, Louvered Back, with AkroBins	A30240YELLO	36
AC3618QV250	Beige Cabinet w/ Quick View Doors, Louvered Back, with AkroBins	A30250YELLO	18

AkroBin Model No.	L	W	H
A30240	14-3/4	8-1/4	7
A30250	14-3/4	16-1/2	7

Secure-View Security Bin Cabinet 36" W x 18" D x 78" H			
Model No.	Description	Bin Model No.	Qty. of Bins
AC3618SV	Gray Cabinet w/ Secure View Mesh Doors, Louvered Back, no Bins	-	-
AC3618SV240	Gray Cabinet w/ Secure View Mesh Doors, Louvered Back, with AkroBins	A30240YELLO	36
AC3618SV250	Gray Cabinet w/ Secure View Mesh Doors, Louvered Back, with AkroBins	A30250YELLO	18

Quantities for Standard Cabinets		AkroBin Quantity to Fit Standard Cabinets - AkroBins Model No.															
Model No.	Description	A30210	A30220	A30224	A30230	A30234	A30235	A30237	A30239	A30240	A30250	A30255	A30260	A30265	A30270	A30320	
AC3618	Cabinet with Flush Doors	144	144	96	72	72	36	60	36	36	18	24	18	28	12	12	
	Back Wall	144	144	96	72	72	36	60	36	36	18	24	18	28	12	12	
AC3624	Doors	102	102	0	0	0	0	0	0	0	0	0	0	0	0	0	
	Cabinet with Louvered Doors: Total	246	246	96	72	72	36	60	36	36	18	24	18	18	12	12	



TiltView® Bin Cabinets

SECURE STORAGE; EASY ACCESS; DURABLE CABINET

Heavy-Duty Bin Cabinets

SPACE-SAVING,
HEAVY-DUTY
STORAGE

- **STURDY** – All-welded 16-gauge steel construction with 7-gauge reinforced corners
- **SECURE** – Heavy-duty steel handle with keyed padlock to ensure complete security



HD4824TVABBE



UP TO
2000
LBS.



HD4824TVBE

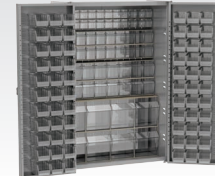

HD4824TVABCH

COLORS

Textured Charcoal Gray, Textured Putty



Padlocked handle
(2 keys included)

Heavy-Duty Cabinet 48" W x 24" D x 72" H		TiltView Bin Quantity				AkroBin Quantity
Model No.	Description	A06702	A06704	A06705	A06706	A30230SCLAR
HD4824TVABBE	Beige Cabinet w/TiltView Bins, AkroBins	4	4	4	4	66
HD4824TVABCH	Charcoal Cabinet w/TiltView Bins, AkroBins	4	4	4	4	66
HD4824TVBE	Beige Cabinet w/TiltView Bins	4	4	4	4	–
HD4824TVCH	Charcoal Cabinet w/TiltView Bins	4	4	4	4	–
HD4824ABE	Beige Cabinet, Louvered Panels on Back & Doors	–	–	–	–	–
HD4824ACH	Charcoal Cabinet, Louvered Panels on Back & Doors	–	–	–	–	–

All packages include TVCLIPs needed to hang bins in cabinet.

Quick-View Security Bin Cabinets

SPACE-SAVING,
VIEWABLE STORAGE

- **VISIBLE** – Lexan™ door panels, combined with clear bins, allow easy viewing, even when cabinet is locked
- **SECURE** – Keyed handle with 3-point locking system
- **STURDY** – All-welded 16-gauge steel construction



AC3618QVTA2



UP TO
1000
LBS.



AC3618QVTA1



AC3618QVTA2

COLORS

Beige

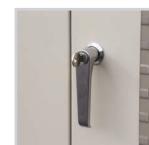

Keyed handle, 2 keys included. Replacement keys available see page 52

Quick-View Security Bin Cabinet 36" W x 18" D x 78" H		TiltView Bin Quantity					AkroBin Quantity
Model No.	Description	A06702	A06703	A06704	A06705	A06706	A30230SCLAR
AC3618QVTA1	Beige Cabinet w/TiltView Bins, AkroBins	–	2	3	3	1	24
AC3618QVTA2	Beige Cabinet w/TiltView Bins, AkroBins	1	1	6	1	–	24
AC3618QV	Beige Cabinet	–	–	–	–	–	–

All packages include TVCLIPs needed to hang bins in cabinet.

Secure Mini-Cabinets

LOCKABLE CABINETS HOLD 12" DEEP AKRODRAWERS®

FEATURES

- 1 Cabinets made of 18-gauge steel
- 2 Welded frame and durable powder-coated finish
- 3 Quick-View Door keeps cabinet contents visible
- 4 4 adjustable shelves
- 5 Lockable flush-mount handle (with 2 keys)
- 6 Louvered back panel for hanging storage bins



ACQV4C82R



ACS4C



ACQV4P

COLORS

Textured Charcoal Gray, Textured Putty



PRODUCT HIGHLIGHTS

- **SECURE** – Lockable cabinet provides secure storage for sensitive supplies
- **NO ASSEMBLY** – Cabinets ship fully assembled
- **CAPACITY** – Secure Mini-Cabinets have 350-lb. weight capacity
- **MOUNTING** – Cabinets are wall-mountable
- **VARIETY** – Quick-View or Solid doors available. Colors include Textured Charcoal Gray, Textured Putty

AkroDrawers®

Quick-View Mini-Cabinet 19¼" W x 13¼" D x 38" H			Dimensions (In.)			Qty. of Drawers
Model No.	Description	Cabinet Color	L	W	H	
ACQV4C ACQV4P	Secure Mini-Cabinet, Quick-View Door, no AkroDrawers	Textured Charcoal Gray Textured Putty	–	–	–	–
ACQV4C42 ACQV4P42	Secure Mini-Cabinet, Quick-View Door with A31142 AkroDrawers	Textured Charcoal Gray Textured Putty	11-5/8	3-3/4	4-5/8	16
ACQV4C62 ACQV4P62	Secure Mini-Cabinet, Quick-View Door with A31162 AkroDrawers	Textured Charcoal Gray Textured Putty	11-5/8	5-9/16	4-5/8	12
ACQV4C82 ACQV4P82	Secure Mini-Cabinet, Quick-View Door with A31182 AkroDrawers	Textured Charcoal Gray Textured Putty	11-5/8	8-3/8	4-5/8	8
ACQV4CAST ACQV4PAST	Secure Mini-Cabinet, Quick-View Door with A31142, A31162 & A31182 AkroDrawers	Textured Charcoal Gray Textured Putty	See Above			4 / 6 / 2

Specify drawer color when ordering: Red, Blue, Yellow, Gray or Crystal Clear available with Gray Cabinet. Blue or Crystal Clear available with Putty Cabinet. One drawer color per unit.



Steel Door Mini-Cabinet 19¼" W x 13¼" D x 38" H			Dimensions (In.)			Qty. of Drawers
Model No.	Description	Cabinet Color	L	W	H	
ACS4C ACS4P	Secure Mini-Cabinet, Steel Door, no AkroDrawers	Textured Charcoal Gray Textured Putty	–	–	–	–
ACS4C42 ACS4P42	Secure Mini-Cabinet, Steel Door with A31142 AkroDrawers	Textured Charcoal Gray Textured Putty	11-5/8	3-3/4	4-5/8	16
ACS4C62 ACS4P62	Secure Mini-Cabinet, Steel Door with A31162 AkroDrawers	Textured Charcoal Gray Textured Putty	11-5/8	5-9/16	4-5/8	12
ACS4C82 ACS4P82	Secure Mini-Cabinet, Steel Door with A31182 AkroDrawers	Textured Charcoal Gray Textured Putty	11-5/8	8-3/8	4-5/8	8
ACS4CAST ACS4PAST	Secure Mini-Cabinet, Steel Door with A31142, A31162 & A31182 AkroDrawers	Textured Charcoal Gray Textured Putty	See Above			4 / 6 / 2

Specify drawer color when ordering: Red, Blue, Yellow, Gray or Crystal Clear available with Gray Cabinet. Blue or Crystal Clear available with Putty Cabinet. One drawer color per unit.

Cabinet Replacement Keys

Model No.	Description
ACKEY	Replacement Key. The key is stamped 1333

Stackable Cabinets

STACKABLE DRAWER STORAGE CABINETS



UP TO
120
LBS.



AD3511C82, AD3517C68, AD3517BSC



AD3511C82R

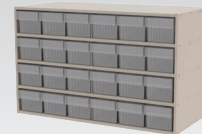

AD3517P68CRY



AD3517BSC

COLORS

Textured Charcoal Gray, Textured Putty



FEATURES

- Stacking a 12" deep cabinet on top of an 18" cabinet provides additional work space
- For secure stacking, special feet nest into recessed dimples in the tops of the cabinets
- Optional base stands provide 8 more inches of height for easier, more comfortable access to lower shelves
- Durable powder-coated finish

PRODUCT HIGHLIGHTS

- EFFICIENT** – Increased storage capacity for AkroDrawers® by providing more space to organize and color code inventory
- STACKABLE** – Units can be stacked up to 3 high
- NO ASSEMBLY** – Cabinets ship fully assembled
- CAPACITY** – Weight capacity: 120 lbs. Combined stacked weight capacity: 200 lbs.
- VARIETY** – 2 sizes and 2 colors: Textured Charcoal Gray, Textured Putty

AkroDrawers®

Stackable Cabinet 35" W x 11" D x 22" H			Bin Dimensions (In.)			Shelf Dimensions (In.)			Qty. of Drawers
Model No.	Description	Cabinet Color	L	W	H	D	L	H	
AD3511C AD3511P	Stackable Cabinet with no AkroDrawers	Textured Charcoal Gray Textured Putty	–	–	–	11	34	4-11/16	–
AD3511CAST2 AD3511PAST2	Stackable Cabinet with A31112 & A31162 AkroDrawers	Textured Charcoal Gray Textured Putty	11-5/8	11-1/8*	4-5/8	11	34	4-11/16	8 / 8
AD3511C62 AD3511P62	Stackable Cabinet with A31162 AkroDrawers	Textured Charcoal Gray Textured Putty	11-5/8	5-9/16	4-5/8	11	34	4-11/16	24
AD3511C82 AD3511P82	Stackable Cabinet with A31182 AkroDrawers	Textured Charcoal Gray Textured Putty	11-5/8	8-3/8	4-5/8	11	34	4-11/16	16

Specify drawer color when ordering: Red, Blue, Yellow, Gray or Crystal Clear available with Gray Cabinet. Blue or Crystal Clear available with Putty Cabinet. One drawer color per unit. *Width of A31112 bin.

Stackable Cabinet 35" W x 17" D x 22" H			Bin Dimensions (In.)			Shelf Dimensions (In.)			Qty. of Drawers
Model No.	Description	Cabinet Color	L	W	H	D	L	H	
AD3517C AD3517P	Stackable Cabinet with no AkroDrawers	Textured Charcoal Gray Textured Putty	–	–	–	17	34	4-11/16	–
AD3517CAST2 AD3517PAST2	Stackable Cabinet with A31118 & A31168 AkroDrawers	Textured Charcoal Gray Textured Putty	17-5/8	11-1/8*	4-5/8	17	34	4-11/16	8 / 8
AD3517C68 AD3517P68	Stackable Cabinet with A31168 AkroDrawers	Textured Charcoal Gray Textured Putty	17-5/8	5-9/16	4-5/8	17	34	4-11/16	24
AD3517C88 AD3517P88	Stackable Cabinet with A31188 AkroDrawers	Textured Charcoal Gray Textured Putty	17-5/8	8-3/8	4-5/8	17	34	4-11/16	16
AD3517CAST AD3517PAST	Stackable Cabinet with A31168 & A31188 AkroDrawers	Textured Charcoal Gray Textured Putty	See Above			17	34	4-11/16	12 / 8

Specify drawer color when ordering: Red, Blue, Yellow, Gray or Crystal Clear available with Gray Cabinet. Blue or Crystal Clear available with Putty Cabinet. One drawer color per unit. *Width of A31118 bin.

Optional Base Stands for Stackable Cabinets			Dimensions (In.)		
Model No.	Description	Base Stand Color	W	D	H
AD3511BSC AD3511BSP	Base Stand for 11" Stackable Cabinet	Textured Charcoal Gray Textured Putty	35-1/4	11-1/4	8
AD3517BSC AD3517BSP	Base Stand for 17" Stackable Cabinet	Textured Charcoal Gray Textured Putty	35-1/4	17-1/4	8

Super Modular Cabinets

STACKABLE OR WALL-MOUNTED DRAWER STORAGE CABINETS



FEATURES

- 1 For secure stacking, special feet nest into recessed dimples in the tops of the cabinets
- 2 AkroDrawers® fit snugly on each shelf so drawer is protected from dust and debris
- 3 Durable powder-coated finish



AD1811CASTCRY

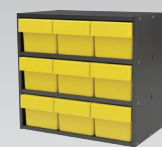

AD1811C62Y



AD1817P88B

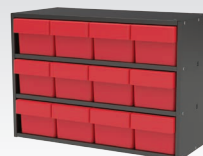

AD2311C62R

COLORS

Textured Charcoal Gray, Textured Putty



PRODUCT HIGHLIGHTS

- **FUNCTIONAL** – Specially designed stackable or wall-mountable cabinets to organize AkroDrawers
- **STACKABLE** – Units can be stacked up to 3 high
- **WALL-MOUNTABLE** – Light assembly required for mounting of 11" cabinets
- **VERSATILE** – 11" cabinets can be hung on louvered panels or rail racks (bracket included)
- **NO ASSEMBLY** – Cabinets ship fully assembled
- **CAPACITY** – Weight capacity: 60 lbs. (18" cabinets); 75 lbs. (23" cabinets). Combined stacked weight capacity: 100 lbs.
- **VARIETY** – 3 sizes and 2 colors: Textured Charcoal Gray, Textured Putty

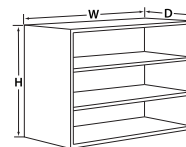

AkroDrawers®

Super Modular Cabinets 18" W x 11" D x 16½" H			Bin Dimensions (In.)			Shelf Dimensions (In.)			Qty. of Drawers
Model No.	Description	Cabinet Color	L	W	H	D	L	H	
AD1811C AD1811P	Small Cabinet with no AkroDrawers	Textured Charcoal Gray Textured Putty	–	–	–	11	17	4-19/32	–
AD1811C62 AD1811P62	Small Cabinet with A31162 AkroDrawers	Textured Charcoal Gray Textured Putty	11-5/8	5-9/16	4-5/8	11	17	4-19/32	9
AD1811C82 AD1811P82	Small Cabinet with A31182 AkroDrawers	Textured Charcoal Gray Textured Putty	11-5/8	8-3/8	4-5/8	11	17	4-19/32	6
AD1811CAST AD1811PAST	Small Cabinet with A31162 and A31182 AkroDrawers	Textured Charcoal Gray Textured Putty	See Above			11	17	4-19/32	6 / 2

Specify drawer color when ordering: Red, Blue, Yellow, Gray or Crystal Clear available with Gray Cabinet. Blue or Crystal Clear available with Putty Cabinet. One drawer color per unit.

UP TO
60
LBS.

Super Modular Cabinets 18" W x 17" D x 16½" H			Bin Dimensions (In.)			Shelf Dimensions (In.)			Qty. of Drawers
Model No.	Description	Cabinet Color	L	W	H	D	L	H	
AD1817C AD1817P	17" Deep Cabinet with no AkroDrawers	Textured Charcoal Gray Textured Putty	–	–	–	17	17	4-19/32	–
AD1817C68 AD1817P68	17" Deep Cabinet with A31168 AkroDrawers	Textured Charcoal Gray Textured Putty	17-5/8	5-9/16	4-5/8	17	17	4-19/32	9
AD1817C88 AD1817P88	17" Deep Cabinet with A31188 AkroDrawers	Textured Charcoal Gray Textured Putty	17-5/8	8-3/8	4-5/8	17	17	4-19/32	6
AD1817CAST AD1817PAST	17" Deep Cabinet with A31168 and A31188 AkroDrawers	Textured Charcoal Gray Textured Putty	See Above			17	17	4-19/32	6 / 2

Specify drawer color when ordering: Red, Blue, Yellow, Gray or Crystal Clear available with Gray Cabinet. Blue or Crystal Clear available with Putty Cabinet. One drawer color per unit.

UP TO
60
LBS.

Super Modular Cabinets 23" W x 11" D x 16½" H			Bin Dimensions (In.)			Shelf Dimensions (In.)			Qty. of Drawers
Model No.	Description	Cabinet Color	L	W	H	D	L	H	
AD2311C AD2311P	Medium Cabinet with no AkroDrawers	Textured Charcoal Gray Textured Putty	–	–	–	11	22	4-19/32	–
AD2311C62 AD2311P62	Medium Cabinet with A31162 AkroDrawers	Textured Charcoal Gray Textured Putty	11-5/8	5-9/16	4-5/8	11	22	4-19/32	12

Specify drawer color when ordering: Red, Blue, Yellow, Gray or Crystal Clear available with Gray Cabinet. Blue or Crystal Clear available with Putty Cabinet. One drawer color per unit.

UP TO
75
LBS.

Wire Shelving Components

BUILD CUSTOM SHELVING UNITS



Construction:

- Frame Wire = 6.0mm
- Deck Wire = 3.3mm
- Truss Wire = 4.5mm



IMAGE INCLUDES:
 AWP74UPRIGHT . . . 4
 AWS2448SHELF . . . 1
 AWS2448SL 4
 AW2448FRAME . . . 1

COLOR
 Chrome

FEATURES

- 1 Open wire design minimizes dust accumulation and improves visibility
- 2 Constructed from steel with a chrome finish
- 3 NSF-certified
- 4 Quick-Adjust Clips lock onto shelf posts, and unlock to adjust shelves
- 5 Leveling bolts screw securely into uprights to level shelf system on uneven surfaces

PRODUCT HIGHLIGHTS

- **EFFICIENT** – Streamlines workflow and order picking
- **FUNCTIONAL** – Works with a variety of Akro-Mils storage products to organize parts and increase efficiency
- **CAPACITY** – Stationary units hold a maximum of 2,000 lbs.; mobile units with 4" casters have a capacity of 400 lbs.; 5" casters have a capacity of 500 lbs. Maximum weight capacity per shelf: 48" or shorter = 800 lbs.; longer than 48" = 600 lbs.
- **ASSEMBLY** – Easy, one-person set-up and installation. No tools required!
- **VARIETY** – Accessories such as ledges, mats and dividers extend the versatility of the shelves. Multiple shelf sizes available, see chart.

Wire Shelving System Components



Horizontal Shelf

Wire Shelves - Chrome

Model No.	Description	Ctn. Qty.
AWS1224SHELF	12" x 24" Horizontal Wire Shelf	4
AWS1236SHELF	12" x 36" Horizontal Wire Shelf	4
AWS1248SHELF	12" x 48" Horizontal Wire Shelf	4
AWS1436SHELF	14" x 36" Horizontal Wire Shelf	4
AWS1824SHELF	18" x 24" Horizontal Wire Shelf	4
AWS1830SHELF	18" x 30" Horizontal Wire Shelf	4
AWS1836SHELF	18" x 36" Horizontal Wire Shelf	4
AWS1848SHELF	18" x 48" Horizontal Wire Shelf	4
AWS1860SHELF	18" x 60" Horizontal Wire Shelf	2
AWS1872SHELF	18" x 72" Horizontal Wire Shelf	2
AWS2424SHELF	24" x 24" Horizontal Wire Shelf	4
AWS2436SHELF	24" x 36" Horizontal Wire Shelf	4
AWS2448SHELF	24" x 48" Horizontal Wire Shelf	4
AWS2460SHELF	24" x 60" Horizontal Wire Shelf	2
AWS2472SHELF	24" x 72" Horizontal Wire Shelf	2
AWS3648SHELF	36" x 48" Horizontal Wire Shelf	2
AWS3660SHELF	36" x 60" Horizontal Wire Shelf	2
AWS3672SHELF	36" x 72" Horizontal Wire Shelf	2



Shelf Posts

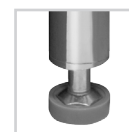

Posts include Leveling Foot

Wire Shelving Posts - Chrome

Model No.	Description	Ctn. Qty.
AWP34UPRIGHT	34" Shelf Post	4
AWP54UPRIGHT	54" Shelf Post	4
AWP63UPRIGHT	63" Shelf Post	4
AWP74UPRIGHT	74" Shelf Post	4
AWP86UPRIGHT	86" Shelf Post	4
AWP96UPRIGHT	96" Shelf Post	4

Wire Shelving Components

BUILD CUSTOM SHELVING UNITS

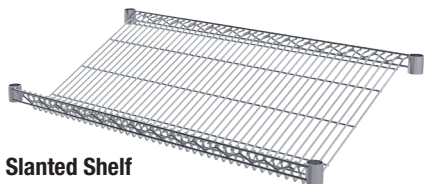

Slanted Shelf

Slanted Wire Shelves - Chrome

Model No.	Description	Ctn. Qty.
AWS1836SL	18" x 36" Slanted Wire Shelf	4
AWS1848SL	18" x 48" Slanted Wire Shelf	4
AWS2436SL	24" x 36" Slanted Wire Shelf	4
AWS2448SL	24" x 48" Slanted Wire Shelf	4



4" Swivel Caster



4" Swivel Caster w/Brake



5" Swivel Caster w/Brake

Caster Sets

Model No.	Description	Pkg. Qty.
AWPCAST4	Set of 4 Casters - 2 w/Brakes 100 x 25 (4")	1
AWPCAST5	Set of 4 Casters - 4 w/Brakes 125 x 25 (5")	1

Akro-Mils does not recommend the usage of casters on shelving units taller than 63".



Angle•Vu™ Label Holder



Angle-Vu Model No.	Dimensions (In.)		Cards Per Sheet		Total No.	
	W	H	Cards Per Sheet	Sheets Per Pack	Cards Per Pack	Label Holders
A29306	3	1-1/4	16	3	48	25

For additional information, see page 14.



3-Sided Frame

Wire Shelving Frames - Chrome

Model No.	Description	Ctn. Qty.
AW1836FRAME	Set of 2 - 3-Sided Frame 18 x 36	2
AW1848FRAME	Set of 2 - 3-Sided Frame 18 x 48	2
AW2436FRAME	Set of 2 - 3-Sided Frame 24 x 36	2
AW2448FRAME	Set of 2 - 3-Sided Frame 24 x 48	2

*Quick-Adjust Clips included with each handle.



Leveling Feet



Steel Feet Immobilizers



"S" Hooks



Quick-Adjust Clips



Post Clamps



Donut Bumper

Wire Shelving Accessories

Model No.	Description	Pkg. Qty.
AWFOOTLEVEL4PK	Set of 4 Leveling Steel Feet	4
AWFOOTPLATE4PK	Set of 4 Steel Feet Immobilizers	4
AWDONUT	Donut Bumper	1
AWSHOOK8PK	Set of 8 "S" Hooks	8
AWCLIP4PK	Set of 4 Quick-Adjust Clips	4
AWCLAMP2PK	Set of 2 Post Clamps	2

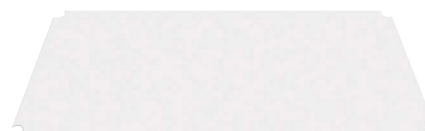

Shelf Liner Mat

Wire Shelving Shelf Liner Mats

Model No.	Description	Ctn. Qty.
AW1224LINER	12" x 24" Shelf Liner	4
AW1236LINER	12" x 36" Shelf Liner	4
AW1248LINER	12" x 48" Shelf Liner	4
AW1824LINER	18" x 24" Shelf Liner	4
AW1836LINER	18" x 36" Shelf Liner	4
AW1848LINER	18" x 48" Shelf Liner	4
AW1860LINER	18" x 60" Shelf Liner	4
AW1872LINER	18" x 72" Shelf Liner	4
AW2424LINER	24" x 24" Shelf Liner	4
AW2436LINER	24" x 36" Shelf Liner	4
AW2448LINER	24" x 48" Shelf Liner	4
AW2460LINER	24" x 60" Shelf Liner	4
AW2472LINER	24" x 72" Shelf Liner	4
AW3660LINER	36" x 60" Shelf Liner	4
AW3672LINER	36" x 72" Shelf Liner	4

Wire Shelving Components

BUILD CUSTOM SHELVING UNITS



Plastic Shelf Divider

Wire/Steel Shelving Shelf Dividers - Plastic

Model No.	Description	Installed Height	Ctn. Qty.
A45612	12" Plastic Shelf Divider (Pk. of 6)	6	1
A45618	18" Plastic Shelf Divider (Pk. of 6)	6	1
A45624	24" Plastic Shelf Divider (Pk. of 6)	6	1

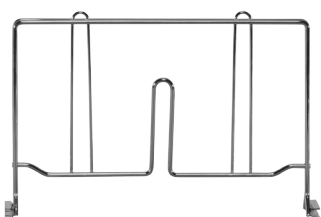

Wire Shelf Divider

Wire Shelving Shelf Dividers - Chrome

Model No.	Description	Installed Height	Ctn. Qty.
AWDIVER12	12" Wire Shelf Divider	7-3/4	4
AWDIVER18	18" Wire Shelf Divider	7-3/4	4
AWDIVER24	24" Wire Shelf Divider	7-3/4	4
AWDIVER36	36" Wire Shelf Divider	7-3/4	4

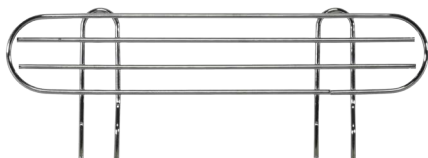

Shelf Ledge

Side & Back Shelf Ledges - Chrome

Model No.	Description	Installed Height	Ctn. Qty.
AWLEDGE12	12" Wire Shelf Ledge	4-5/16	4
AWLEDGE18	18" Wire Shelf Ledge	4-5/16	4
AWLEDGE24	24" Wire Shelf Ledge	4-5/16	4
AWLEDGE36	36" Wire Shelf Ledge	4-5/16	4
AWLEDGE48	48" Wire Shelf Ledge	4-5/16	4
AWLEDGE60	60" Wire Shelf Ledge	4-5/16	4
AWLEDGE72	72" Wire Shelf Ledge	4-5/16	4



Handle with Posts



Push Handle

Wire Shelving Handles - Chrome

Model No.	Description	Ctn. Qty.
AWUHDL18	Handle with 2 Posts 18"	2
AWUHDL24	Handle with 2 Posts 24"	2
AWPHDL18*	18" Push Handle	2
AWPHDL24*	24" Push Handle	2

*Quick-Adjust Clips included with each handle.



Post-Mount Bracket



Wall-Mount Bracket

Wire Shelving Wall Mounting Brackets - Chrome

Model No.	Description	Ctn. Qty.
AW18SPBKT*	18" Single Post Bracket	4
AW18DPBKT*	18" Double Post Bracket	4
AW24SPBKT*	24" Single Post Bracket	4
AW24DPBKT*	24" Double Post Bracket	4
AW18SWBKT	18" Single Wall Bracket	4
AW18DWBKT	18" Double Wall Bracket	4
AW24SWBKT	24" Single Wall Bracket	4
AW24DWBKT	24" Double Wall Bracket	4

Wall mounting hardware included. Wire shelves sold separately. *Posts sold separately.

Wire Shelving Starter Units

COMPLETE SHELVING UNITS

Wire Shelving 4-Shelf Starter Units come with 4 shelves, 4 posts and 8 S-Hooks for extending shelving end-to-end, back-to-back or 90 degrees. Posts include leveling feet. Make a mobile unit by adding AWPCAST4 or AWPCAST5.

Wire Shelving Starter Units		Components		
Model No.	Description	Post Qty.	Shelf Qty.	S-Hook Qty.
AWS541224SU	Wire Shelving 54" High 12 x 24 Starter Unit	4	4	1 - 8 Pack
AWS541236SU	Wire Shelving 54" High 12 x 36 Starter Unit	4	4	1 - 8 Pack
AWS541248SU	Wire Shelving 54" High 12 x 48 Starter Unit	4	4	1 - 8 Pack
AWS541436SU	Wire Shelving 54" High 14 x 36 Starter Unit	4	4	1 - 8 Pack
AWS541824SU	Wire Shelving 54" High 18 x 24 Starter Unit	4	4	1 - 8 Pack
AWS541830SU	Wire Shelving 54" High 18 x 30 Starter Unit	4	4	1 - 8 Pack
AWS541836SU	Wire Shelving 54" High 18 x 36 Starter Unit	4	4	1 - 8 Pack
AWS541848SU	Wire Shelving 54" High 18 x 48 Starter Unit	4	4	1 - 8 Pack
AWS541860SU	Wire Shelving 54" High 18 x 60 Starter Unit	4	4	1 - 8 Pack
AWS541872SU	Wire Shelving 54" High 18 x 72 Starter Unit	4	4	1 - 8 Pack
AWS542424SU	Wire Shelving 54" High 24 x 24 Starter Unit	4	4	1 - 8 Pack
AWS542436SU	Wire Shelving 54" High 24 x 36 Starter Unit	4	4	1 - 8 Pack
AWS542448SU	Wire Shelving 54" High 24 x 48 Starter Unit	4	4	1 - 8 Pack
AWS542460SU	Wire Shelving 54" High 24 x 60 Starter Unit	4	4	1 - 8 Pack
AWS542472SU	Wire Shelving 54" High 24 x 72 Starter Unit	4	4	1 - 8 Pack
AWS543648SU	Wire Shelving 54" High 36 x 48 Starter Unit	4	4	1 - 8 Pack
AWS543660SU	Wire Shelving 54" High 36 x 60 Starter Unit	4	4	1 - 8 Pack
AWS543672SU	Wire Shelving 54" High 36 x 72 Starter Unit	4	4	1 - 8 Pack
AWS631224SU	Wire Shelving 63" High 12 x 24 Starter Unit	4	4	1 - 8 Pack
AWS631236SU	Wire Shelving 63" High 12 x 36 Starter Unit	4	4	1 - 8 Pack
AWS631248SU	Wire Shelving 63" High 12 x 48 Starter Unit	4	4	1 - 8 Pack
AWS631436SU	Wire Shelving 63" High 14 x 36 Starter Unit	4	4	1 - 8 Pack
AWS631824SU	Wire Shelving 63" High 18 x 24 Starter Unit	4	4	1 - 8 Pack
AWS631830SU	Wire Shelving 63" High 18 x 30 Starter Unit	4	4	1 - 8 Pack
AWS631836SU	Wire Shelving 63" High 18 x 36 Starter Unit	4	4	1 - 8 Pack
AWS631848SU	Wire Shelving 63" High 18 x 48 Starter Unit	4	4	1 - 8 Pack
AWS631860SU	Wire Shelving 63" High 18 x 60 Starter Unit	4	4	1 - 8 Pack
AWS631872SU	Wire Shelving 63" High 18 x 72 Starter Unit	4	4	1 - 8 Pack
AWS632424SU	Wire Shelving 63" High 24 x 24 Starter Unit	4	4	1 - 8 Pack
AWS632436SU	Wire Shelving 63" High 24 x 36 Starter Unit	4	4	1 - 8 Pack
AWS632448SU	Wire Shelving 63" High 24 x 48 Starter Unit	4	4	1 - 8 Pack
AWS632460SU	Wire Shelving 63" High 24 x 60 Starter Unit	4	4	1 - 8 Pack
AWS632472SU	Wire Shelving 63" High 24 x 72 Starter Unit	4	4	1 - 8 Pack
AWS633648SU	Wire Shelving 63" High 36 x 48 Starter Unit	4	4	1 - 8 Pack
AWS633660SU	Wire Shelving 63" High 36 x 60 Starter Unit	4	4	1 - 8 Pack
AWS633672SU	Wire Shelving 63" High 36 x 72 Starter Unit	4	4	1 - 8 Pack

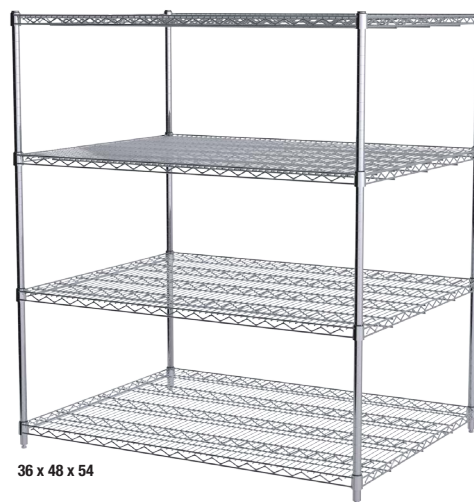

Wire Shelving Starter Units

COMPLETE SHELVING UNITS

Wire Shelving 4-Shelf Starter Units come with 4 shelves, 4 posts and 8 S-Hooks for extending shelving end-to-end, back-to-back or 90 degrees. Posts include leveling feet. Make a mobile unit by adding AWPCAST4 or AWPCAST5.

Wire Shelving Starter Units		Components		
Model No.	Description	Post Qty.	Shelf Qty.	S-Hook Qty.
AWS741224SU	Wire Shelving 74" High 12 x 24 Starter Unit	4	4	1 - 8 Pack
AWS741236SU	Wire Shelving 74" High 12 x 36 Starter Unit	4	4	1 - 8 Pack
AWS741248SU	Wire Shelving 74" High 12 x 48 Starter Unit	4	4	1 - 8 Pack
AWS741436SU	Wire Shelving 74" High 14 x 36 Starter Unit	4	4	1 - 8 Pack
AWS741824SU	Wire Shelving 74" High 18 x 24 Starter Unit	4	4	1 - 8 Pack
AWS741830SU	Wire Shelving 74" High 18 x 30 Starter Unit	4	4	1 - 8 Pack
AWS741836SU	Wire Shelving 74" High 18 x 36 Starter Unit	4	4	1 - 8 Pack
AWS741848SU	Wire Shelving 74" High 18 x 48 Starter Unit	4	4	1 - 8 Pack
AWS741860SU	Wire Shelving 74" High 18 x 60 Starter Unit	4	4	1 - 8 Pack
AWS741872SU	Wire Shelving 74" High 18 x 72 Starter Unit	4	4	1 - 8 Pack
AWS742424SU	Wire Shelving 74" High 24 x 24 Starter Unit	4	4	1 - 8 Pack
AWS742436SU	Wire Shelving 74" High 24 x 36 Starter Unit	4	4	1 - 8 Pack
AWS742448SU	Wire Shelving 74" High 24 x 48 Starter Unit	4	4	1 - 8 Pack
AWS742460SU	Wire Shelving 74" High 24 x 60 Starter Unit	4	4	1 - 8 Pack
AWS742472SU	Wire Shelving 74" High 24 x 72 Starter Unit	4	4	1 - 8 Pack
AWS743648SU	Wire Shelving 74" High 36 x 48 Starter Unit	4	4	1 - 8 Pack
AWS743660SU	Wire Shelving 74" High 36 x 60 Starter Unit	4	4	1 - 8 Pack
AWS743672SU	Wire Shelving 74" High 36 x 72 Starter Unit	4	4	1 - 8 Pack
AWS861224SU	Wire Shelving 86" High 12 x 24 Starter Unit	4	4	1 - 8 Pack
AWS861236SU	Wire Shelving 86" High 12 x 36 Starter Unit	4	4	1 - 8 Pack
AWS861248SU	Wire Shelving 86" High 12 x 48 Starter Unit	4	4	1 - 8 Pack
AWS861436SU	Wire Shelving 86" High 14 x 36 Starter Unit	4	4	1 - 8 Pack
AWS861824SU	Wire Shelving 86" High 18 x 24 Starter Unit	4	4	1 - 8 Pack
AWS861830SU	Wire Shelving 86" High 18 x 30 Starter Unit	4	4	1 - 8 Pack
AWS861836SU	Wire Shelving 86" High 18 x 36 Starter Unit	4	4	1 - 8 Pack
AWS861848SU	Wire Shelving 86" High 18 x 48 Starter Unit	4	4	1 - 8 Pack
AWS861860SU	Wire Shelving 86" High 18 x 60 Starter Unit	4	4	1 - 8 Pack
AWS861872SU	Wire Shelving 86" High 18 x 72 Starter Unit	4	4	1 - 8 Pack
AWS862424SU	Wire Shelving 86" High 24 x 24 Starter Unit	4	4	1 - 8 Pack
AWS862436SU	Wire Shelving 86" High 24 x 36 Starter Unit	4	4	1 - 8 Pack
AWS862448SU	Wire Shelving 86" High 24 x 48 Starter Unit	4	4	1 - 8 Pack
AWS862460SU	Wire Shelving 86" High 24 x 60 Starter Unit	4	4	1 - 8 Pack
AWS862472SU	Wire Shelving 86" High 24 x 72 Starter Unit	4	4	1 - 8 Pack
AWS863648SU	Wire Shelving 86" High 36 x 48 Starter Unit	4	4	1 - 8 Pack
AWS863660SU	Wire Shelving 86" High 36 x 60 Starter Unit	4	4	1 - 8 Pack
AWS863672SU	Wire Shelving 86" High 36 x 72 Starter Unit	4	4	1 - 8 Pack

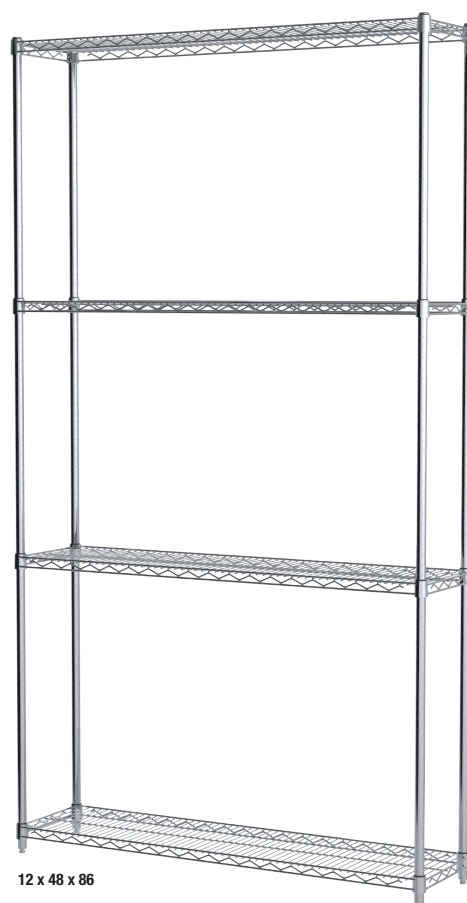
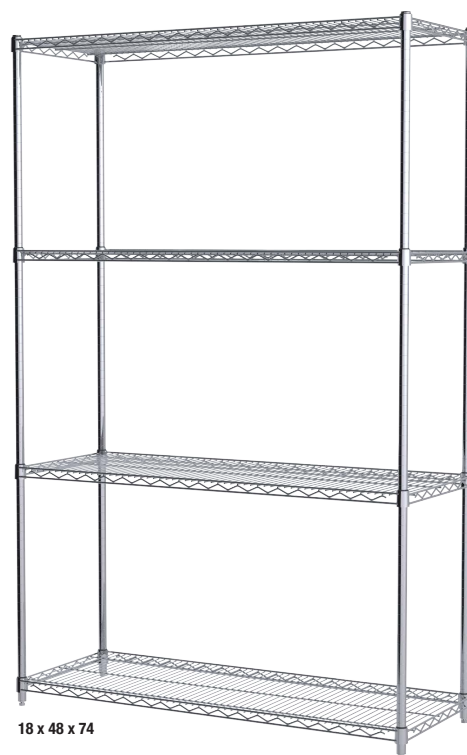

Mobile Wire Shelving Starter Units

COMPLETE SHELVING UNITS



Mobile Slanted Shelf Starter Units

Mobile Slanted Shelf Starter Units - Heavy-duty wire shelving units. Shelves adjust in 1" increments. Unit height = 68". Shelf Angle (installed) = 27°

Units Include:

4 - chrome slanted wire shelves with Quick-Adjust Post Sleeves, 4 - posts with Leveling Feet, 2 - 3-Sided Frames, 5" swivel casters -

2 with brakes; 2 without brakes, 4 - Donut Bumpers.

Mobile Slanted Shelf Starter Units		Components			
Model No.	Description	Post Qty.	Shelf Qty.	Unit Weight	Weight Cap.
AWS1836SLMU	18" x 36" Mobile Starter Unit	4	4	65	500
AWS1848SLMU	18" x 48" Mobile Starter Unit	4	4	78	500
AWS2436SLMU	24" x 36" Mobile Starter Unit	4	4	72	500
AWS2448SLMU	24" x 48" Mobile Starter Unit	4	4	87	500



Mobile Wire Utility Carts

READY TO ASSEMBLE IN A SINGLE CONVENIENT CARTON

Mobile Wire Utility Carts - All-purpose utility carts with chrome finish. Shelves adjust in 1" increments. All components arrive in a single carton. Cart height = 38-3/8".

Units Include:

2 - Handle with Posts, wire shelves with Quick-Adjust Post Sleeves, 5" swivel casters, 2 with brakes; 2 without brakes, 4 - Donut Bumpers.

Optional Shelf Ledges and Shelf Dividers available.

Mobile Wire Utility Carts				
Model No.	Description	Ctn. Qty.	Unit Weight	Weight Cap.
AWCART18362	18" x 36" 2-Shelf Cart	1	34	500
AWCART24362	24" x 36" 2-Shelf Cart	1	43.5	500
AWCART24482	24" x 48" 2-Shelf Cart	1	50	500
AWCART18363	18" x 36" 3-Shelf Cart	1	40	500
AWCART24363	24" x 36" 3-Shelf Cart	1	55	500
AWCART24483	24" x 48" 3-Shelf Cart	1	64	500



Wire Shelving Systems

MORE THAN 70 SYSTEM OPTIONS AVAILABLE



AWS184830260G

AkroBin Wire Shelving Systems			Bin Dimensions (In.)			Shelf Dimensions (In.)			Quantity	
Model No.	Description	AkroBin Colors	L	W	H	D	L	H	Bins	Shelves
AWS143630320	Wire Shelving w/ A30320 Bins	B, R, Y, G, S, BK, SC	8-5/8	33	5	14	36	74	12	11
AWS143630240	Wire Shelving w/ A30240 Bins	B, R, Y, G, S, BK, SC	14-3/4	8-1/4	7	14	36	74	36	4
AWS143630250	Wire Shelving w/ A30250 Bins	B, R, Y, G, S, BK, SC	14-3/4	16-1/2	7	14	36	74	18	4
AWS184830260	Wire Shelving w/ A30260 Bins	B, R, Y, G, S, BK, SC	18	11	10	18	48	74	24‡	6
AWS183630265	Wire Shelving w/ A30265 Bins	B, R, Y, G, S, BK, SC	18	8-1/4	9	18	36	74	18‡	5
AWS183630270	Wire Shelving w/ A30270 Bins	B, R, Y, G, S, BK, SC	18	16-1/2	11	18	36	74	9‡	5
AWS244830348BE	Wire Shelving w/ A30348 Bins	BEIGE	20-1/2	8-1/4	7	24	48	74	42‡	5
AWS2460M30358	Mobile Wire Shelving w/ A30358 Bins	BEIGE	20-1/2	11	7	24	60	68	30	6

Bin color code: R=Red, B=Blue, Y=Yellow, G=Green, S=Stone, BK=Black, SC=Clear. Specify one bin color when ordering. ‡Bonus bins included.

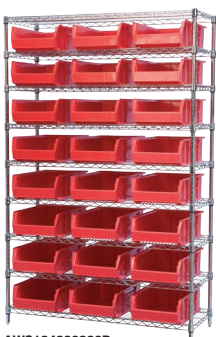

AWS184830280R

Super-Size AkroBin Wire Shelving Systems			Bin Dimensions (In.)			Shelf Dimensions (In.)			Quantity	
Model No.	Description	Super-Size AkroBin Colors	L	W	H	D	L	H	Bins	Shelves
AWS184830280	Wire Shelving w/ A30280 Bins	R, B, Y, SC	20	12-3/8	6	18	48	74	24	9
AWS184830281	Wire Shelving w/ A30281 Bins	R, B, Y, SC	20	12-3/8	8	18	48	74	18	7
AWS184830282	Wire Shelving w/ A30282 Bins	R, B, Y, SC	20	12-3/8	12	18	48	74	12	5
AWS184830283	Wire Shelving w/ A30283 Bins	R, B, Y, SC	20	18	12	18	48	74	8	5
AWS1848SAB	Wire Shelving w/ A30280, 281, 282, 283 Bins	R, B, Y, SC	See Above			18	48	74	4 / 3 / 4 / 4‡	6
AWS24360284	Wire Shelving w/ A30284 Bins	R, B, Y, SC	23-7/8	8-1/4	7	24	36	74	28	8
AWS24360287	Wire Shelving w/ A30287 Bins	R, B, Y, SC	23-7/8	11	10	24	36	74	16‡	6
AWS24360288	Wire Shelving w/ A30288 Bins	R, B, Y, SC	23-7/8	16-1/2	11	24	36	74	12	3
AWS243605AB	Wire Shelving w/ A30287 & A30288 Bins	R, B, Y, SC	See Above			24	36	74	12 / 6‡	3
AWS24361288	Wire Shelving w/ A30288 Bins	R, B, Y, SC	23-7/8	16-1/2	11	24	36	63	10	3

Bin color code: R=Red, B=Blue, Y=Yellow, G=Green, SC=Clear. Specify one bin color when ordering. ‡Bonus bins included.



AWS183613014B

Stak-N-Store Wire Shelving Systems			Bin Dimensions (In.)			Shelf Dimensions (In.)			Quantity	
Model No.	Description	Stak-N-Store Bin Colors	L	W	H	D	L	H	Bins	Shelves
AWS184813017	Wire Shelving w/ A13017 Bins	GRY, R, B, W, SC	15-1/2	19-7/8	12-7/16	18	48	74	9	5
AWS183613014	Wire Shelving w/ A13014 Bins	GRY, R, B, SC	17-1/2	10-7/8	12-1/2	18	36	74	12	5
AWS183613018	Wire Shelving w/ A13018 Bins	GRY, R, B, SC	17-1/2	16-1/2	12-1/2	18	36	74	8	5
AWS1836SNS	Wire Shelving w/ A13014 & A13018 Bins	GRY, R, B, SC	See Above			18	36	74	8 / 6 ‡	5

Bin color code: R=Red, B=Blue, W=White, G=Gray, SC=Clear. Specify one bin color when ordering. ‡Bonus bins included.



AWS143630120Y

4" Shelf Bin Wire Shelving Systems			Bin Dimensions (In.)			Shelf Dimensions (In.)			Quantity	
Model No.	Description	Shelf Bin Colors	L	W	H	D	L	H	Bins	Shelves
AWS143630120	Wire Shelving w/ A30120 Bins	R, B, Y, G, W, SC	11-5/8	4-1/8	4	14	36	74	96	12
AWS143630130	Wire Shelving w/ A30130 Bins	R, B, Y, G, W, SC	11-5/8	6-5/8	4	14	36	74	60	12
AWS143630150	Wire Shelving w/ A30150 Bins	R, B, Y, G, W, SC	11-5/8	8-3/8	4	14	36	74	48	12
AWS143630170	Wire Shelving w/ A30170 Bins	R, B, Y, G, W, SC	11-5/8	11-1/8	4	14	36	74	36	12
AWS183630128	Wire Shelving w/ A30128 Bins	R, B, Y, G, W, SC	17-7/8	4-1/8	4	18	36	74	96	12
AWS183630138	Wire Shelving w/ A30138 Bins	R, B, Y, G, W, SC	17-7/8	6-5/8	4	18	36	74	60	12
AWS183630158	Wire Shelving w/ A30158 Bins	R, B, Y, G, W, SC	17-7/8	8-3/8	4	18	36	74	48	12
AWS183630178	Wire Shelving w/ A30178 Bins	R, B, Y, G, W, SC	17-7/8	11-1/8	4	18	36	74	36	12
AWS244830124	Wire Shelving w/ A30124 Bins	R, B, Y, G, W, SC	23-5/8	4-1/8	4	24	48	74	120	12
AWS244830164	Wire Shelving w/ A30164 Bins	R, B, Y, G, W, SC	23-5/8	6-5/8	4	24	48	74	66	12
AWS244830184	Wire Shelving w/ A30184 Bins	R, B, Y, G, W, SC	23-5/8	8-3/8	4	24	48	74	60‡	12
AWS244830174	Wire Shelving w/ A30174 Bins	R, B, Y, G, W, SC	23-5/8	11-1/8	4	24	48	74	48‡	12

Bin color code: R=Red, B=Blue, Y=Yellow, G=Green, W=White, SC=Clear. Specify one bin color when ordering. ‡Bonus bins included.

Wire Shelving Systems

MORE THAN 70 SYSTEM OPTIONS AVAILABLE

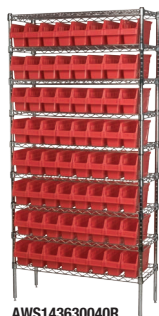

AWS143630040R

6" ShelfMax Wire Shelving Systems			Bin Dimensions (In.)			Shelf Dimensions (In.)			Quantity	
Model No.	Description	ShelfMax Bin Colors	L	W	H	D	L	H	Bins	Shelves
AWS143630040	Wire Shelving w/ A30040 Bins	R, B, Y, SC	11-5/8	4-1/8	6	14	36	74	64	9
AWS143630090	Wire Shelving w/ A30090 Bins	R, B, Y, SC	11-5/8	6-5/8	6	14	36	74	40	9
AWS143630080	Wire Shelving w/ A30080 Bins	R, B, Y, SC	11-5/8	8-3/8	6	14	36	74	32	9
AWS143630010	Wire Shelving w/ A30010 Bins	R, B, Y, SC	11-5/8	11-1/8	6	14	36	74	24	9
AWS183630048	Wire Shelving w/ A30048 Bins	R, B, Y, SC	17-7/8	4-1/8	6	18	36	74	64	9
AWS183630098	Wire Shelving w/ A30098 Bins	R, B, Y, SC	17-7/8	6-5/8	6	18	36	74	40	9
AWS183630088	Wire Shelving w/ A30088 Bins	R, B, Y, SC	17-7/8	8-3/8	6	18	36	74	32	9
AWS183630018	Wire Shelving w/ A30018 Bins	R, B, Y, SC	17-7/8	11-1/8	6	18	36	74	24	9
AWS243630044	Wire Shelving w/ A30044 Bins	R, B, Y, SC	17-7/8	8-3/8	6	24	36	74	64	9
AWS243630094	Wire Shelving w/ A30094 Bins	R, B, Y, SC	23-5/8	6-5/8	6	24	36	74	40	9
AWS243630084	Wire Shelving w/ A30084 Bins	R, B, Y, SC	23-5/8	8-3/8	6	24	36	74	36‡	9
AWS243630014	Wire Shelving w/ A30014 Bins	R, B, Y, SC	23-5/8	11-1/8	6	24	36	74	24	9

Bin color code: R=Red, B=Blue, Y=Yellow, SC=Clear. Specify one bin color when ordering. ‡Bonus bins included.



AWS143630860Y

ShelfMax8 Wire Shelving Systems			Bin Dimensions (In.)			Shelf Dimensions (In.)			Quantity	
Model No.	Description	ShelfMax8 Bin Colors	L	W	H	D	L	H	Bins	Shelves
AWS143630840	Wire Shelving with A30840 Bins	R, B, Y, SC	11-5/8	4-1/8	8	14	36	74	64‡	8
AWS143630860	Wire Shelving with A30860 Bins	R, B, Y, SC	11-5/8	6-5/8	8	14	36	74	40‡	8
AWS143630880	Wire Shelving with A30880 Bins	R, B, Y, SC	11-5/8	8-2/7	8	14	36	74	32‡	8
AWS143630800	Wire Shelving with A30800 Bins	R, B, Y, SC	11-5/8	11-1/8	8	14	36	74	24‡	8
AWS183630848	Wire Shelving with A30848 Bins	R, B, Y, SC	17-5/8	4-1/8	8	18	36	74	56	8
AWS183630868	Wire Shelving with A30868 Bins	R, B, Y, SC	17-5/8	6-5/8	8	18	36	74	40‡	8
AWS183630888	Wire Shelving with A30888 Bins	R, B, Y, SC	17-5/8	8-2/7	8	18	36	74	32‡	8
AWS183630808	Wire Shelving with A30808 Bins	R, B, Y, SC	17-5/8	11-1/8	8	18	36	74	24‡	8
AWS183630818	Wire Shelving with A30818 Bins	R, B, Y, SC	17-5/8	16-1/2	8	18	36	74	16‡	8
AWS183630838	Wire Shelving with A30838 Bins	R, B, Y, SC	17-5/8	33	8	18	36	74	8‡	8
AWS243630844	Wire Shelving with A30844 Bins	R, B, Y, SC	23-5/8	4-1/8	8	24	36	74	56	8
AWS243630864	Wire Shelving with A30864 Bins	R, B, Y, SC	23-5/8	6-5/8	8	24	36	74	40‡	8
AWS243630884	Wire Shelving with A30884 Bins	R, B, Y, SC	23-5/8	8-2/7	8	24	36	74	32‡	8
AWS243630804	Wire Shelving with A30804 Bins	R, B, Y, SC	23-5/8	11-1/8	8	24	36	74	24‡	8
AWS243630814	Wire Shelving with A30814 Bins	R, B, Y, SC	23-5/8	16-1/2	8	24	36	74	16‡	8

Bin color code: R=Red, B=Blue, Y=Yellow, SC=Clear. Specify one bin color when ordering. ‡Bonus bins included.



AWS143636442B

Indicator Wire Shelving Systems			Bin Dimensions (In.)			Shelf Dimensions (In.)			Quantity	
Model No.	Description	Indicator Colors	L	W	H	D	L	H	Bins	Shelves
AWS143636442B	Wire Shelving w/ A36442 Bins	Blue/Orange	11-5/8	4-1/4	4	14	36	74	96*	12
AWS143636462B	Wire Shelving w/ A36462 Bins	Blue/Orange	11-5/8	6-3/4	4	14	36	74	60*	12
AWS183636448B	Wire Shelving w/ A36448 Bins	Blue/Orange	17-7/8	4-1/8	4	18	36	74	96*	12
AWS183636468B	Wire Shelving w/ A36468 Bins	Blue/Orange	17-7/8	6-5/8	4	18	36	74	60*	12

*Bonus Bins Included.

Wire Shelving Systems

MORE THAN 70 SYSTEM OPTIONS AVAILABLE



AWS244837608G

Straight Wall Container Wire Shelving Systems			Bin Dimensions (In.)			Shelf Dimensions (In.)			Quantity	
Model No.	Description	Container Colors	L	W	H	D	L	H	Bins	Shelves
AWS244837608	Wire Shelving w/ A37608 Containers	R, GRY	23-3/4	15-3/4	8-1/4	24	48	74	12	6

Bin color code: R=Red, GRY=Gray. Specify one bin color when ordering.



AWS2460M34240

Akro-Tub Wire Shelving Systems			Bin Dimensions (In.)			Shelf Dimensions (In.)			Quantity	
Model No.	Description	Akro-Tub Colors	L	W	H	D	L	H	Bins	Shelves
AWS1836M34301	Mobile Wire Shelving w/ A34301 Tubs	GRY	17-1/2	11	8	18	36	68	24‡	7
AWS2460M34240	Mobile Wire Shelving w/ A34240 Tubs	GRY	19	24-1/2	9-1/2	24	60	68	12	4

‡Bonus bins included.



AWS183630318R

System Bin Wire Shelving Systems			Bin Dimensions (In.)			Shelf Dimensions (In.)			Quantity	
Model No.	Description	System Bin Colors	L	W	H	D	L	H	Bins	Shelves
AWS143630312	Wire Shelving w/ A30312 Bins	R, Y, B	33	12	5	14	36	74	10	11
AWS183630318	Wire Shelving w/ A30318 Bins	R, Y, B	33	18	5	18	36	74	10	11

Bin color code: R=Red, B=Blue, Y=Yellow. Specify one bin color when ordering.



AWS246035225B

Nest & Stack Wire Shelving Systems			Bin Dimensions (In.)			Shelf Dimensions (In.)			Quantity	
Model No.	Description	Nest & Stack Tote Colors	L	W	H	D	L	H	Bins	Shelves
AWS183635180	Wire Shelving w/ A35180 Totes	B, R, GRY	18	11	6	18	36	74	30‡	9
AWS246035225	Wire Shelving w/ A35225 Totes	B, R, GRY	23-1/2	19-1/2	10	24	60	74	12	4

Lids sold separately. Bin color code: R=Red, B=Blue, GRY=Gray. Specify one bin color when ordering. ‡Bonus bins included.



AWS183633168GRY

Akro-Grid Wire Shelving Systems			Bin Dimensions (In.)			Shelf Dimensions (In.)			Quantity	
Model No.	Description	Akro-Grid Tote Colors	L	W	H	D	L	H	Bins	Shelves
AWS183633166	Wire Shelving w/ A33166 Grids	B, R, GRY	16-1/2	10-7/8	6	18	36	74	24	9
AWS183633168	Wire Shelving w/ A33168 Grids	B, R, GRY	16-1/2	10-7/8	8	18	36	74	18	7

Bin color code: R=Red, B=Blue, GRY=Gray. Specify one bin color when ordering. Dividers sold separately.

Steel Shelving Systems

MORE THAN 60 SYSTEM OPTIONS AVAILABLE



AS3679293

FEATURES

- 1 Manufactured from high-grade, 22-gauge steel
- 2 Powder-coated finish
- 3 Quickly change shelf heights with compression clips
- 4 Adjustable shelves

PRODUCT HIGHLIGHTS

- **EFFICIENT** – Can be ordered independently or purchased with bins for a complete system
- **FUNCTIONAL** – Efficiently organize large, heavy items and improve workflow
- **VARIETY** – 5 shelf sizes available: 12" x 36", 18" x 36", 18" x 42", 24" x 36", 30" x 36"
- **CAPACITY** – Shelving units have 355 to 600 lb. weight capacity per shelf when assembled and installed per instructions. Per shelf weight capacity: 12" x 36": 500 lbs.; 18" x 36": 550 lbs.; 18" x 42": 355 lbs.; 24" x 36": 550 lbs.; 30" x 36": 600 lbs.

Steel Shelving		Shelf Dimensions (In.)			Quantity
Model Number	Description	D	L	H	Shelves
ASC1279	12" Enclosed Shelving (no AkroDrawers)	12	36	79	13
ASC1879	18" Enclosed Shelving (no AkroDrawers)	18	36	79	13
AS1279	12" Shelving (no Bins)	12	36	79	13
AS1879	18" Shelving (no Bins)	18	36	79	13
AS2479	24" Shelving (no Bins)	24	36	79	4
AS3679	30" Shelving (no Bins)	30	36	79	4
AS187936	36" Shelving (no Bins)	18	36	79	6
AS187942	42" Shelving (no Bins)	18	42	79	6

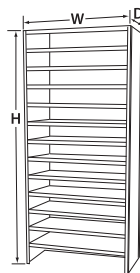

AS1279



AS1879



AS187936



AS187942



AS2479



AS3679



ASC1279



ASC1879

COLOR
Gray



ACCESSORIES

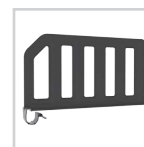

Plastic Dividers
Available in 12", 18"
and 24" depths. (See
page 60)

Steel Shelving Systems

MORE THAN 60 SYSTEM OPTIONS AVAILABLE

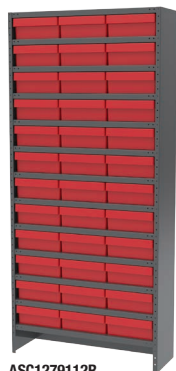

ASC1279112R

12" Enclosed Steel Shelving Systems			Bin Dimensions (In.)			Shelf Dimensions (In.)			Quantity	
Model Number	Description	AkroDrawer Colors	L	W	H	D	L	H	Drawers	Shelves
ASC1279112	Shelving with A31112 AkroDrawers	R, Y, B, GRY, CRY	11-5/8	11-1/8	4-5/8	12	36	79	36	13
ASC1279142	Shelving with A31142 AkroDrawers	R, Y, B, GRY, CRY	11-5/8	3-3/4	4-5/8	12	36	79	108	13
ASC1279162	Shelving with A31162 AkroDrawers	R, Y, B, GRY, CRY	11-5/8	5-9/16	4-5/8	12	36	79	72	13
ASC1279182	Shelving with A31182 AkroDrawers	R, Y, B, GRY, CRY	11-5/8	8-3/8	4-5/8	12	36	79	48	13
ASC1279AST	Shelving with A31142, A31162, A31182 AkroDrawers	R, Y, B, GRY, CRY	See Above			12	36	79	30 / 36 / 12 ‡	13

Drawer color code: R=Red, B=Blue, Y=Yellow, GRY=Gray, CRY=Clear. Specify drawer color when ordering. Only one color per unit. ‡Bonus drawers included.

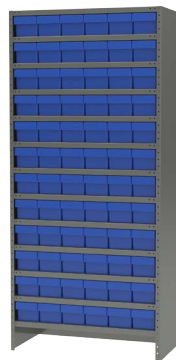

ASC1879168B

18" Enclosed Steel Shelving Systems			Bin Dimensions (In.)			Shelf Dimensions (In.)			Quantity	
Model Number	Description	AkroDrawer Colors	L	W	H	D	L	H	Drawers	Shelves
ASC1879118	Shelving with A31118 AkroDrawers	R, Y, B, GRY, CRY	17-5/8	11-1/8	4-5/8	18	36	79	36	13
ASC1879148	Shelving with A31148 AkroDrawers	R, Y, B, GRY, CRY	17-5/8	3-3/4	4-5/8	18	36	79	108	13
ASC1879168	Shelving with A31168 AkroDrawers	R, Y, B, GRY, CRY	17-5/8	5-9/16	4-5/8	18	36	79	72	13
ASC1879188	Shelving with A31188 AkroDrawers	R, Y, B, GRY, CRY	17-5/8	8-3/8	4-5/8	18	36	79	48	13
ASC1879AST	Shelving with A31168, A31188 AkroDrawers	R, Y, B, GRY, CRY	See Above			18	36	79	36 / 24	13

Drawer color code: R=Red, B=Blue, Y=Yellow, GRY=Gray, CRY=Clear. Specify drawer color when ordering. Only one color per unit.



AS3679293R

Super-Size AkroBin Steel Shelving Systems			Bin Dimensions (In.)			Shelf Dimensions (In.)			Quantity	
Model Number	Description	Super-Size AkroBin Colors	L	W	H	D	L	H	Bins	Shelves
AS2479284	24" Shelving with A30284 Bins	B, R, Y, SC	23-7/8	8-1/4	7	24	36	79	32 ‡	9
AS2479287	24" Shelving with A30287 Bins	B, R, Y, SC	23-7/8	11	10	24	36	79	24 ‡	3
AS2479288	24" Shelving with A30288 Bins	B, R, Y, SC	23-7/8	16-1/2	11	24	36	79	12	4
AS2479ASSORT	24" Shelving with A30287/A30288 Bins	B, R, Y, SC	See Above			24	36	79	12 / 6	3
AS3679292	30" Shelving with A30292 Bins	B, R, Y, SC	29-7/8	11	10	30	36	79	24	3
AS3679293	30" Shelving with A30293 Bins	B, R, Y, SC	29-7/8	16-1/2	11	30	36	79	12	4
AS3679ASSORT	30" Shelving with A30292/A30293 Bins	B, R, Y, SC	See Above			30	36	79	12/6	3

Bin color code: R=Red, B=Blue, Y=Yellow, SC=Clear. Specify one bin color when ordering. ‡Bonus bins included.

Steel Shelving Systems

MORE THAN 60 SYSTEM OPTIONS AVAILABLE

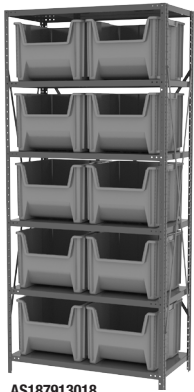

AS187913018

Stak-N-Store Steel Shelving Systems			Bin Dimensions (In.)			Shelf Dimensions (In.)			Quantity	
Model Number	Description	Stak-N-Store Color	L	W	H	D	L	H	Bins	Shelves
AS187913014	36" Shelving, with A13014 Bins	B, R, GRY, SC	17-1/2	10-7/8	12-1/2	18	36	79	16‡	6
AS187913018	36" Shelving, with A13018 Bins	B, R, GRY, SC	17-1/2	16-1/2	12-1/2	18	36	79	10	6
AS1879ASORT	36" Shelving, with A13014, A13018 Bins	B, R, GRY, SC	See Above			18	36	79	8/6‡	6
AS187913017	42" Shelving, with A13017 Bins	B, R, GRY, SC, W	15-1/4	19-7/8	12-7/16	18	42	79	12‡	6

Bin color code: R=Red, B=Blue, W=White, GRY=, SC=Clear. Specify one bin color when ordering. ‡Bonus bins included.



AS1879178Y

Shelf Bin Steel Shelving Systems			Bin Dimensions (In.)			Shelf Dimensions (In.)			Quantity	
Model Number	Description	Shelf Bin Colors	L	W	H	D	L	H	Bins	Shelves
AS1279110	12" Shelving with A30110 Bins	R, B, Y, G, W, SC	11-5/8	2-3/4	4	12	36	79	144	13
AS1279120	12" Shelving with A30120 Bins	R, B, Y, G, W, SC	11-5/8	4-1/8	4	12	36	79	96	13
AS1279130	12" Shelving with A30130 Bins	R, B, Y, G, W, SC	11-5/8	6-5/8	4	12	36	79	60	13
AS1279150	12" Shelving with A30150 Bins	R, B, Y, G, W, SC	11-5/8	8-3/8	4	12	36	79	48	13
AS1279170	12" Shelving with A30170 Bins	R, B, Y, G, W, SC	11-5/8	11-1/8	4	12	36	79	36	13
AS1879128	18" Shelving with A30128 Bins	R, B, Y, G, W, SC	17-7/8	4-1/8	4	18	36	79	96	13
AS1879138	18" Shelving with A30138 Bins	R, B, Y, G, W, SC	17-7/8	6-5/8	4	18	36	79	60	13
AS1879158	18" Shelving with A30158 Bins	R, B, Y, G, W, SC	17-7/8	8-3/8	4	18	36	79	48	13
AS1879178	18" Shelving with A30178 Bins	R, B, Y, G, W, SC	17-7/8	11-1/8	4	18	36	79	36	13

Bin color code: R=Red, B=Blue, Y=Yellow, G=Green, W=White, SC=Clear. Specify one bin color when ordering.



AS2479094R

ShelfMax Steel Shelving Systems			Bin Dimensions (In.)			Shelf Dimensions (In.)			Quantity	
Model Number	Description	ShelfMax Bin Colors	L	W	H	D	L	H	Bins	Shelves
AS1279040	12" Steel Shelving with A30040 Bins	R, B, Y, SC	11-5/8	4-1/8	6	12	36	79	80	11
AS1279090	12" Steel Shelving with A30090 Bins	R, B, Y, SC	11-5/8	6-5/8	6	12	36	79	50	11
AS1279080	12" Steel Shelving with A30080 Bins	R, B, Y, SC	11-5/8	8-3/8	6	12	36	79	40	11
AS1279010	12" Steel Shelving with A30010 Bins	R, B, Y, SC	11-5/8	11-1/8	6	12	36	79	32‡	11
AS1879048	18" Steel Shelving with A30048 Bins	R, B, Y, SC	17-7/8	4-1/8	6	18	36	79	80	11
AS1879098	18" Steel Shelving with A30098 Bins	R, B, Y, SC	17-7/8	6-5/8	6	18	36	79	50	11
AS1879088	18" Steel Shelving with A30088 Bins	R, B, Y, SC	17-7/8	8-3/8	6	18	36	79	40	11
AS1879018	18" Steel Shelving with A30018 Bins	R, B, Y, SC	17-7/8	11-1/8	6	18	36	79	32‡	11
AS2479044	24" Steel Shelving with A30044 Bins	R, B, Y, SC	23-5/8	4-1/8	6	24	36	79	80	11
AS2479094	24" Steel Shelving with A30094 Bins	R, B, Y, SC	23-5/8	6-5/8	6	24	36	79	50	11
AS2479084	24" Steel Shelving with A30084 Bins	R, B, Y, SC	23-5/8	8-3/8	6	24	36	79	42‡	11
AS2479014	24" Steel Shelving with A30014 Bins	R, B, Y, SC	23-5/8	11-1/8	6	24	36	79	30	11

Bin color code: R=Red, B=Blue, Y=Yellow, SC=Clear. Specify one bin color when ordering.

Steel Shelving Systems

MORE THAN 60 SYSTEM OPTIONS AVAILABLE

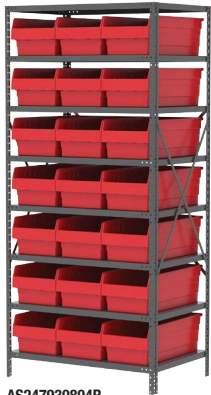

AS247930804R

ShelfMax8 Steel Shelving Systems			Bin Dimensions (In.)			Shelf Dimensions (In.)			Quantity	
Model Number	Description		L	W	H	D	L	H	Bins	Shelves
AS127930840	12" Steel Shelving with A30840 Bins	R, B, Y, SC	11-5/8	4-1/8	8	12	36	79	64‡	8
AS127930860	12" Steel Shelving with A30860 Bins	R, B, Y, SC	11-5/8	6-5/8	8	12	36	79	40‡	8
AS127930880	12" Steel Shelving with A30880 Bins	R, B, Y, SC	11-5/8	8-2/7	8	12	36	79	32‡	8
AS127930800	12" Steel Shelving with A30800 Bins	R, B, Y, SC	11-5/8	11-1/8	8	12	36	79	24‡	8
AS187930848	18" Steel Shelving with A30848 Bins	R, B, Y, SC	17-7/8	4-1/8	8	12	36	79	56	8
AS187930868	18" Steel Shelving with A30868 Bins	R, B, Y, SC	17-7/8	6-5/8	8	18	36	79	40‡	8
AS187930888	18" Steel Shelving with A30888 Bins	R, B, Y, SC	17-7/8	8-2/7	8	18	36	79	32‡	8
AS187930808	18" Steel Shelving with A30808 Bins	R, B, Y, SC	17-7/8	11-1/8	8	18	36	79	24‡	8
AS187930818	18" Steel Shelving with A30818 Bins	R, B, Y, SC	17-7/8	16-1/2	8	18	36	79	16‡	8
AS187930838	18" Steel Shelving with A30838 Bins	R, B, Y, SC	17-7/8	33	8	18	36	79	8‡	8
AS247930844	24" Steel Shelving with A30844 Bins	R, B, Y, SC	23-5/8	4-1/8	8	24	36	79	56	8
AS247930864	24" Steel Shelving with A30864 Bins	R, B, Y, SC	23-5/8	6-5/8	8	24	36	79	40‡	8
AS247930884	24" Steel Shelving with A30884 Bins	R, B, Y, SC	23-5/8	8-2/7	8	24	36	79	32‡	8
AS247930804	24" Steel Shelving with A30804 Bins	R, B, Y, SC	23-5/8	11-1/8	8	24	36	79	24‡	8
AS247930814	24" Steel Shelving with A30814 Bins	R, B, Y, SC	23-5/8	16-1/2	8	24	36	79	16‡	8

Bin color code: R=Red, B=Blue, Y=Yellow, SC=Clear. Specify one bin color when ordering. ‡Bonus bins included.

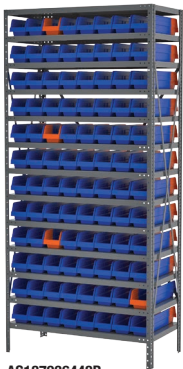

AS187936448B

Indicator Bin Steel Shelving Systems			Bin Dimensions (In.)			Shelf Dimensions (In.)			Quantity	
Model Number	Description	Indicator Colors	L	W	H	D	L	H	Bins	Shelves
AS127936442B	Shelving, with A36442BLUE Indicator Bins	Blue/Orange	11-5/8	4-1/4	4	12	36	79	96	13
AS127936462B	Shelving, with A36462BLUE Indicator Bins	Blue/Orange	11-5/8	6-3/4	4	12	36	79	60	13
AS187936448B	Shelving, with A36448BLUE Indicator Bins	Blue/Orange	17-7/8	4-1/8	4	18	36	79	96	13
AS187936468B	Shelving, with A36468BLUE Indicator Bins	Blue/Orange	17-7/8	6-5/8	4	18	36	79	60	13



AS1879318Y

System Bin Steel Shelving Systems			Bin Dimensions (In.)			Shelf Dimensions (In.)			Quantity	
Model Number	Description	System Bin Color	L	W	H	D	L	H	Bins	Shelves
AS1279312	12" Shelving with System Bins	B, R, Y	33	12	5	12	36	79	10	11
AS1879318	18" Shelving with System Bins	B, R, Y	33	18	5	18	36	79	10	11

Bin color code: R=Red, B=Blue, Y=Yellow. Specify one bin color when ordering.

Dollies

DURABLE INDUSTRIAL-GRADE POLYMER & STEEL DOLLIES

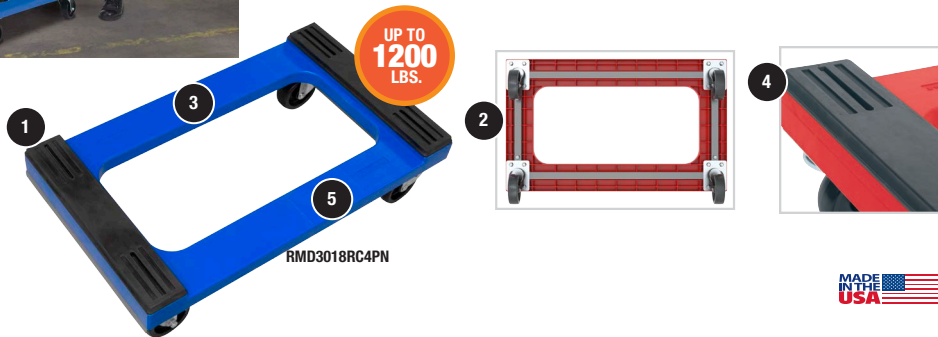

RMD3018RC4PN

MADE IN THE USA

FEATURES

- 1 1-piece deck design
- 2 Steel-reinforced under deck
- 3 High-impact, durable polyethylene construction
- 4 Flush deck or padded models available for cargo protection
- 5 4 bolt-on swivel casters for maximum mobility

PRODUCT HIGHLIGHTS

- **QUALITY** – Easy to clean, non-porous platform will not rot, mildew or splinter
- **CAPACITY** – 1,200 lb. weight capacity
- **ASSEMBLY** – Quick, easy assembly
- **VARIETY** – 6 models, 3 colors

Polyethylene Dollies		Dimensions (In.)				
Model No.	Description	L	W	Caster Type	Overall Height (In.)	Weight Capacity (lbs.)
RMD3018F4PN	Flush Polyethylene w/ Casters	30	18	4" Polyolefin	6-5/8	1200
RMD3018RC4PN	Padded Polyethylene w/ Casters	30	18	4" Polyolefin	7-13/16	1200
RMD3018FN	Flush Polyethylene w/o Casters	30	18	–	1-3/8	–
RMD3018RCN	Padded Polyethylene w/o Casters	30	18	–	2-1/2	–
RMD3018F4RX	Flush Polyethylene w/ Casters	30	18	4" Blue Elastic Rubber	6-5/8	1200
RMD3018RC4RX	Padded Polyethylene w/ Casters	30	18	4" Blue Elastic Rubber	7-13/16	1200

Specify color when ordering. AB=Blue, AR=Red, K=Black.

COLORS

Red, Blue, Black

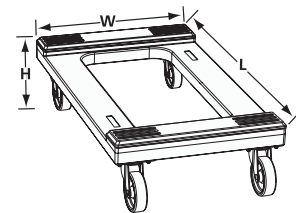

CASTERS & WHEELS

Caster & Wheel choices allow you to resolve problems of noise control, floor protection, impact or abrasion resistance, or load capacity. See page 95 for more caster information.



DY22190700



DY282305M509000



DY3027040099000

Dollies		Outside Dimensions (In.)				
Model No.	Description	L	W	H	Weight lbs.	Weight Capacity lbs.
DY22190700	Aluminum ChillPac Dolly	22.38	18.88	8	24	1,800
DY282305M509000	Plastic Stack & Nest MultiTray Dolly	28	23	5.38	11	500
DY3027040099000	Welded Steel Bakery Tray Dolly	29.5	26.5	4	28	500
DY48400900	Welded Steel Bulk Box Dolly	48.5	40.5	9	46	2,500
DY48450900	Welded Steel Bulk Box Dolly	48.5	45.4	9	65	2,500

Bakery Trays sold separately.



DY48400900 shown with optional tow bar

Dollies: Steel

HEAVY-DUTY, ALL-STEEL CONSTRUCTION

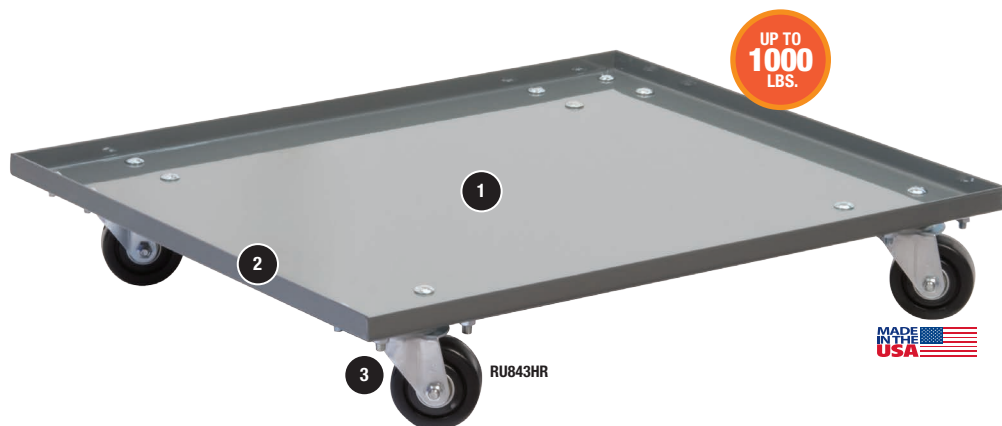

RU843HR



RD844HR



RU854HR



RD854HR

COLOR
Gray



FEATURES

- 1 Durable, powder-coated finish
- 2 All-welded 13-gauge steel or 1½" x 1½" x 1/8" angle construction
- 3 Bolt-on casters for easy replacement

PRODUCT HIGHLIGHTS

- **OPEN** – Open structural angle dollies, 1½" x 1½" x 1/8"
- **SOLID** – Solid decks are smooth, 13-gauge steel
- **LIPS UP or DOWN** – 1½" lip turned down for a smooth surface; order lips up for a contained area
- **CAPACITY** – Up to 1,000 lbs.
- **VARIETY** – 4 models, 4 sizes: 16" x 27", 18" x 24", 18" x 30", 24" x 36". Custom sizes and casters available

CASTERS & WHEELS

Caster & Wheel choices allow you to resolve problems of noise control, floor protection, impact or abrasion resistance, or load capacity. See page 89 for more caster information.

Steel Dollies

Style	Lips Down Model No.	Lips Up Model No.	Capacity (lbs.)	Caster Type	Caster Size (In.)	Deck Height Up (Inches)	Deck Height Down (Inches)
Solid Dolly	RD843HR	RU843HR	900	Polyolefin	3 x 1-1/4	5-1/2	4-1/8
Solid Dolly	RD843SS	RU843SS	1000	Steel	3 x 1-1/4	5-1/2	4-1/8
Solid Dolly	RD844HR	RU844HR	1000	Polyolefin	4 x 1-1/4	6-5/8	5-1/4
Solid Dolly	RD844SS	RU844SS	1000	Steel	4 x 1-1/4	6-5/8	5-1/4
Open Angle	RD853HR	RU853HR	900	Polyolefin	3 x 1-1/4	5-3/4	4-3/8
Open Angle	RD853SS	RU853SS	1000	Steel	3 x 1-1/4	5-3/4	4-3/8
Open Angle	RD854HR	RU854HR	1000	Polyolefin	4 x 1-1/4	6-7/8	5-1/2
Open Angle	RD854SS	RU854SS	1000	Steel	4 x 1-1/4	6-7/8	5-1/2

RHDLHOOK

Pull hook for pulling dollies; order your dolly with welded-on tow eye.

ACCESSORIES

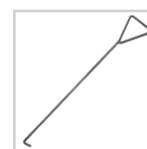

RHDLHOOK

Heavy-duty pull hook from 1/2" diameter steel for pulling dollies. Place order for a dolly with a welded-on eye.

Dollies: Steel

CUSTOM SIZES TO FIT BINS & CONTAINERS



RU843TP1721 with A30288



RU843HR1519 with A13017



RU843HR1828 with A35300



RU843HR1621 with A33226



RU843HR1420 with A39120



RU843HR1624 with A37688



Super-Size AkroBin Steel Dollies		Dimensions (In.)			Capacity/Quantity		
Model No.	Bin Compatibility	L	W	H	Casters	Ctn. Qty.	Capacity
RU843HR2018	A30280, A30281, A30282 & A30283 Bins – Fits 1 wide	17-13/16	18-3/8	4-11/16	3" Polyolefin	1	900 lbs.
RU843HR2918	A30290 Bins – Fits 1 wide	26-13/16	18-3/8	4-11/16	3" Polyolefin	1	900 lbs.
RU843TP2122	A30286 & A30287 Bins – Fits 2 wide	20-7/8	21-7/8	4-11/16	3" Polyolefin	1	900 lbs.
RU843TP2227	A30292 Bins – Fits 2 wide	21-7/8	26-7/8	4-11/16	3" Polyolefin	1	900 lbs.
RU843TP1721	A30284 Bins – Fits 2 wide A30288 Bins – Fits 1 wide	16-1/2	20-7/8	4-11/16	3" Polyolefin	1	900 lbs.
RU843TP1727	A30293 Bins – Fits 1 wide	16-1/2	26-7/8	4-11/16	3" Polyolefin	1	900 lbs.
RU843TP1821	A30289 Bins – Fits 1 wide	18-1/2	20-7/8	4-11/16	3" Polyolefin	1	900 lbs.

Bins sold separately, see page 10.

UP TO
900
LBS.

Stak-N-Store Bin Steel Dollies		Dimensions (In.)			Capacity/Quantity		
Model No.	Bin Compatibility	L	W	H	Casters	Ctn. Qty.	Capacity
RU843HR1617	A13018	16-5/8	15-3/4	4-1/2	3" Polyolefin	1	900 lbs.
RU843HR1519	A13017	19-1/4	14-5/8	4-1/2	3" Polyolefin	1	900 lbs.

Bins sold separately, see page 12.

UP TO
900
LBS.

Nest & Stack Tote Steel Dollies		Dimensions (In.)			Capacity/Quantity		
Model No.	Bin Compatibility	L	W	H	Casters	Ctn. Qty.	Capacity
RU843HR1422	A35240	16-5/8	15-3/4	4-1/2	3" Polyolefin	1	900 lbs.
RU843HR1822	A35225, A35230	21-1/2	17-1/2	4-1/2	3" Polyolefin	1	900 lbs.
RU843HR1828	A35300	27-3/8	17-3/8	4-1/2	3" Polyolefin	1	900 lbs.

Bins sold separately, see page 24.

UP TO
900
LBS.

Akro-Grid Steel Dollies		Dimensions (In.)			Capacity/Quantity		
Model No.	Bin Compatibility	L	W	H	Casters	Ctn. Qty.	Capacity
RU843HR1621	A33220, A33228	21-1/8	16-1/8	5-1/8	3" Polyolefin	1	900 lbs.

Bins sold separately, see page 26.

UP TO
900
LBS.

Attached Lid Container Steel Dollies		Dimensions (In.)			Capacity/Quantity		
Model No.	Bin Compatibility	L	W	H	Casters	Ctn. Qty.	Capacity
RU843HR1420	A39085, A39120, A39170, A66486CLDBL	19-7/8	14-1/4	5-1/8	3" Polyolefin	1	900 lbs.

Bins sold separately, see page 23.

UP TO
900
LBS.

Straight Wall Container Steel Dollies		Dimensions (In.)			Capacity/Quantity		
Model No.	Bin Compatibility	L	W	H	Casters	Ctn. Qty.	Capacity
RU843HR1624	A37608, A37678, A37688, A37616, A37676, A37686, A37612, A37672, A37682, A38358GRY	24-3/8	16-3/8	5-1/8	3" Polyolefin	1	900 lbs.

Bins sold separately, see page 29.

UP TO
900
LBS.

Dollies: Wood

KILN-DRIED HARDWOODS PREVENT WARPING & SHRINKAGE



FEATURES

- 1 Kiln-dried hardwood deck with countersunk bolt holes for a smooth working surface
- 2 Non-marking bolt-on 3" swivel casters with polyolefin wheels for maximum mobility
- 3 Zinc-plated rigs and hardware resist corrosion

PRODUCT HIGHLIGHTS

- **QUALITY** – All boards are cut and planed to $\frac{7}{8}$ " with guaranteed consistent quality
- **CAPACITY** – Four 3" polyolefin swivel casters offer 900 lb. weight capacity (See caster options for up to 1,400 lb. capacity)
- **VARIETY** – Dolly styles include Solid, Flush, Regular, Carpet End, Rubber Cap, All-Carpet Solid

All 3" polyolefin casters are not alike! Akro-Mils gives you more of what you paid for! See page 89.

ACCESSORIES



Wheel Locks

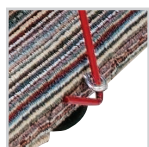

Tow Eye R1495



Tow Handle RTOWHANDLE Tee-handle dolly pull hook made from $\frac{5}{16}$ " diameter steel.

Wood Dollies		Dimensions (In.)	
Model No.	Description	L	W
RD2416S3P	Solid Dolly	24	16
RD2718S3P	Solid Dolly	27	18
RD3018S3P	Solid Dolly	30	18
RD3624S3P	Solid Dolly	36	24
RD4824S3P	Solid Dolly	48	24
RD2416F3P	Flush Dolly	24	16
RD2718F3P	Flush Dolly	27	18
RD3018F3P	Flush Dolly	30	18
RD3624F3P	Flush Dolly	36	24
RD4824F3P	Flush Dolly	48	24
RD2416R3P	Regular Dolly	24	16
RD3018R3P	Regular Dolly	30	18
RD3624R3P	Regular Dolly	36	24
RD3018CE3P	Carpet End Dolly	30	18
RD3624CE3P	Carpet End Dolly	36	24
RD2718RC3P	Rubber Cap Dolly	27	18
RD3018RC3P	Rubber Cap Dolly	30	18
RD3018AC3P	All-Carpet Solid Dolly	30	18
RD3624AC3P	All-Carpet Solid Dolly	36	24

CASTERS & WHEELS

Caster & Wheel choices allow you to resolve problems of noise control, floor protection, impact or abrasion resistance, or load capacity. See page 89 for more caster information.

Caster Options

Model No.	Description	Weight Capacity (lbs.)
3P ‡	3" Polyolefin Casters	900
4P	4" Polyolefin Casters	1200
5P	5" Polyolefin Casters	1400
3R	3" Gray Non-Marking Rubber	900
35R	3-1/2" Gray Non-Marking Rubber	900
4Rx	4" Blue Elastic Rubber	900
4R	4" Non-Marking Rubber Casters	1100
5R	5" Non-Marking Rubber Casters	1350

‡ Standard casters.

Brake Kits

Model No.	Description
R1130BRK	3" Brake Kits for Hard Rubber Casters
R1151BRK	3" Brake Kits for Polyolefin Casters

Brake kits installed on two swivel casters – optional (non-returnable).



RD3018S3P



RD3018F3P



RD3018R3P



RD3018CE3P



RD3018RC3P



RD3018AC3P

Platform Trucks Series 5

ECONOMICALLY PRICED TRUCK SHIPS FLAT TO SAVE MONEY



RPT24485J5G6GY



RPT27545J5P6GY



RPT30605K5N8GY

COLOR
Gray



FEATURES

- 1 4/4 kiln-dried unfinished hardwood deck
- 2 Powder-coated 13-gauge fixed steel handle offered in open or crossbar styles

PRODUCT HIGHLIGHTS

- **DURABLE** – Kiln-dried tongue and groove unfinished hardwood deck
- **CAPACITY** – 4 caster options for up to 2,400-lb. capacity
- **UNASSEMBLED** – Cart ships unassembled, saving freight costs and warehouse space
- **DECK SIZES** – 24" x 48", 27" x 54", 30" x 60"



Series 5 Platform Trucks		Caster		
Model No.	Description	Type	Size (In.)	Weight Capacity (Lbs.)*
RPT24485J5G6GY	24 x 48, Open Handle	Polyurethane	6	2400
RPT24485K5G6GY	24 x 48, Crossbar Handle	Polyurethane	6	2400
RPT24485J5P6GY	24 x 48, Open Handle	Polyolefin	6	2100
RPT24485K5P6GY	24 x 48, Crossbar Handle	Polyolefin	6	2100
RPT24485J5N8GY	24 x 48, Open Handle	Pneumatic	8	1000
RPT24485K5N8GY	24 x 48, Crossbar Handle	Pneumatic	8	1000
RPT24485J5M8GY	24 x 48, Open Handle	Mold-On	8	1500
RPT24485K5M8GY	24 x 48, Crossbar Handle	Mold-On	8	1500
RPT27545J5G6GY	27 x 54, Open Handle	Polyurethane	6	2400
RPT27545K5G6GY	27 x 54, Crossbar Handle	Polyurethane	6	2400
RPT27545J5P6GY	27 x 54, Open Handle	Polyolefin	6	2100
RPT27545K5P6GY	27 x 54, Crossbar Handle	Polyolefin	6	2100

*Based on evenly distributed load on 4 casters. Other caster sets are available. Minimum quantities apply.

Series 5 Platform Trucks		Caster		
Model No.	Description	Type	Size (In.)	Weight Capacity (Lbs.)*
RPT27545J5N8GY	27 x 54, Open Handle	Pneumatic	8	1000
RPT27545K5N8GY	27 x 54, Crossbar Handle	Pneumatic	8	1000
RPT27545J5M8GY	27 x 54, Open Handle	Mold-On	8	1500
RPT27545K5M8GY	27 x 54, Crossbar Handle	Mold-On	8	1500
RPT30605J5G6GY	30 x 60, Open Handle	Polyurethane	6	2400
RPT30605K5G6GY	30 x 60, Crossbar Handle	Polyurethane	6	2400
RPT30605J5P6GY	30 x 60, Open Handle	Polyolefin	6	2100
RPT30605K5P6GY	30 x 60, Crossbar Handle	Polyolefin	6	2100
RPT30605J5N8GY	30 x 60, Open Handle	Pneumatic	8	1000
RPT30605K5N8GY	30 x 60, Crossbar Handle	Pneumatic	8	1000
RPT30605J5M8GY	30 x 60, Open Handle	Mold-On	8	1500
RPT30605K5M8GY	30 x 60, Crossbar Handle	Mold-On	8	1500

*Based on evenly distributed load on 4 casters. Other caster sets are available. Minimum quantities apply.

CASTER & WHEEL CHOICES

allow you to resolve problems of noise control, floor protection, impact or abrasion resistance, or load capacity. See page 95 for more information.



Mold-On Rubber



Pneumatic



Polyolefin



Polyurethane

Platform Trucks Wood Deck

FEATURING KILN-DRIED TONGUE & GROOVE HARDWOOD DECKS



How to Order Your Wood Platform Truck



SERIES 1 with Polyolefin Casters

SERIES 2 with Mold-On Casters



STEP 1

PICK A DECK SIZE

All decks are 4/4 (7/8" thick) hardwood with tongue and groove construction.

Standard deck sizes:

24" x 48" • 27" x 54" • 30" x 60" • 36" x 72"

STEP 2

PICK A DECK STYLE (1-2)

Series 1 – All Wood

- Standard with removable crossbar pipe handle at swivel end

Series 2 – Wood Deck with Steel Frame

- 2" x 2" x 1/8" all-welded steel angle frame keeps cart square (on 36" x 72" deck, 2" x 2" x 3/16")
- Heavy-duty steel frame for additional deck support
- Standard with removable crossbar pipe handle at swivel end
- The wood deck is reinforced with longitudinal stiffeners for maximum capacity. (See caster options for capacity)

STEP 3

PICK SUPERSTRUCTURE (A-D)

Superstructure



Open pipe handle

COLOR

Red

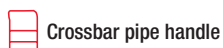

Crossbar pipe handle

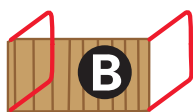
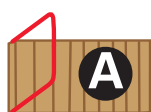

Crossbar handles are removable

STEP 4

PICK RUNNING GEARS (4-7)



Rigid caster



Swivel caster

4



Four Swivel

5



Two Rigid
Two Swivel

6



Tilt

7



Tilt Quad

STEP 5

PICK CASTER TYPE (P, M, Y, N, R, S)

Heavy-duty casters are bolted on for easy replacement. Caster options allow 1,180 to 3,000 lb. capacities.



Polyolefin

5 x 2 • 6 x 2



Mold-On Rubber

5 x 2 • 6 x 2 • 8 x 2



Polyurethane

6 x 2 • 8 x 2



Pneumatic

8 x 3 • 10 x 3 1/2



Non-Marking Rubber

6 x 2 • 8 x 2



Steel

8 x 2

Caster & Wheel choices allow you to resolve problems of noise control, floor protection, impact or abrasion resistance, or load capacity. See page 89 for more caster and wheel information.

STEP 6

PICK CASTER SIZE – 5", 6", 8", 10"

Call your Akro-Mils distributor with your model number today to order

model #	step 1	step 2	step 3	step 4	step 5	step 6
Platform Truck	Size	Series	Super-structure	Running Gear Type	Caster Wheel	Caster Wheel Diameter
RPT	2448 2754 3060 3672	1 2	A B C D	4 5 6 7	P M Y N R S	5 6 8 10
RPT	3060	2	A	5	Y	6



Ships fully assembled & ready to use!

= RPT30602A5Y6



Platform Trucks : Steel, Super-Heavy-Duty

ADDITIONAL HEAVY-DUTY TRUCK OPTIONS



Platform Trucks – Steel Deck

FEATURES

- 1 Durable powder-coated finish
- 2 Smooth 13-gauge steel deck and frame
- 3 Steel reinforcements run lengthwise under the deck
- 4 Heavy-duty industrial casters (standard 2 swivel, 2 rigid) bolt-on for easy replacement
- 5 Removable crossbar handle

PRODUCT HIGHLIGHTS

- **HEAVY-DUTY** – 13-gauge steel deck with longitudinal steel underdeck reinforcements
- **CAPACITY** – Caster options allow 800 to 2,000 lb. capacities
- **NO ASSEMBLY** – Trucks are shipped assembled and ready to use
- **VARIETY** – Special order platform trucks are available. Select from 8 standard deck sizes and a wide variety of handle and caster options
- **DECK SIZES** – 24" x 36", 24" x 48", 24" x 60", 27" x 54", 30" x 48", 30" x 60", 36" x 60", 36" x 72"



COLOR
Gray



Platform Trucks - Steel

Model No.	Caster Type*	Caster Size (In.)	Weight Capacity (lbs.)	Deck Height (In.)
R2108FPB	Full Pneumatic	8 x 2	1200	11-1/2
R2125MRB	Mold-On Rubber	5 x 2	1200	8
R2168MRB	Mold-On Rubber	8 x 2	2000	11

* See page 95 for full description of casters and wheels.

Platform Trucks – Super-Heavy-Duty

FEATURES

- 1 Powder-coated steel frame
- 2 Super-heavy-duty kiln-dried hardwood deck
- 3 Steel C-channel and removable side rails allow for deck repair/replacement
- 4 High deck for minimal bending
- 5 Load wheels on solid 1" steel axle
- 6 Removable crossbar handle

PRODUCT HIGHLIGHTS

- **HEAVY-DUTY** – Caster options allow 1,200 to 4,000 lb. capacities
- **NO ASSEMBLY** – Trucks are shipped completely assembled and ready to use
- **VARIETY** – Deck sizes: 24" x 48", 30" x 48", 30" x 60", 36" x 72"



COLOR
Gray



ACCESSORIES



Floor Locks



Wheel Locks



Corner Bumpers



Continuous Bumpers

Platform Trucks - Super-Heavy-Duty

Model No.	Caster Type*	Caster Size (In.)	Wheel Size (In.)	Weight Capacity (lbs.)	Deck Height (In.)
R2178MRB	Mold-On Rubber	8 x 2	8 x 2	2000	12-1/4
R219885MRB	Mold-On Rubber	8 x 2	8 x 2-1/2	2500	12-1/2
R221812MRB	Mold-On Rubber	8 x 2	12 x 2-1/2	3000	16
R2258516MRB	Mold-On Rubber	8 x 2-1/2	16 x 3	4000	19-1/2

* See page 95 for full description of casters and wheels.

VERSA/Deck™

VERSATILE STRUCTURAL FOAM PLATFORM TRUCK



UP TO 2000 LBS.



FEATURES

- 1 More than 70 different handle/caster configurations
- 2 Non-skid structural foam deck is easy-to-clean and won't rot, chip or rust
- 3 Jam Bolts, standard on all models, hold handles in place
- 4 **NEW FEATURE!** 4 molded-in tie-down slots secure items during transport
- 5 Steel reinforcements provide durability and a weight capacity of up to 2,000 lbs.
- 6 Handles and rails feature a durable, powder-coated finish

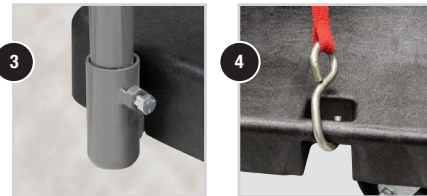

PRODUCT HIGHLIGHTS

- **DURABLE** – HDPE molded structural foam with steel reinforcement
- **CAPACITY** – Up to 2,000 lb. weight capacity
- **VARIETY** – Customizable for your exact needs with multiple handle, deck and caster options. Brake and floor lock options are available as well. Decks sizes: 24" x 48", 30" x 60"

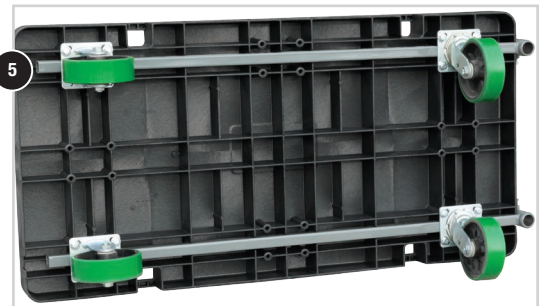

Handle Styles:

Open Swayback



Crossbar Swayback



Open Straight

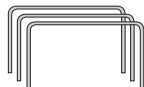

Wire Mesh Sides



High/Low



Posts



COLOR
Black/Gray



CASTER & WHEEL CHOICES

allow you to resolve problems of noise control, floor protection, impact or abrasion resistance, or load capacity. See page 89 for more information.



Mold-On Rubber



Pneumatic



Polyolefin



Polyurethane



Thermoplastic



Easy-Roll



**Handle Style "A"**

1 Crossbar Swayback
or
1 Open Swayback

Models ending in "11"
have open handles,
those ending in "12"
have crossbar handles

Style "A" – 1 Crossbar Swayback or 1 Open Swayback

Model No.	Deck Size	Caster Type	Caster Size (In.)
R90110A1411	24 x 48	Pneumatic	10
R90110A1412	24 x 48	Pneumatic	10
R90162A1411	24 x 48	Polyolefin	6
R90162A1412	24 x 48	Polyolefin	6
R90163A1411	24 x 48	Polyurethane	6
R90163A1412	24 x 48	Polyurethane	6
R90181A1411	24 x 48	Pneumatic	8
R90181A1412	24 x 48	Pneumatic	8
R90182A1411	24 x 48	Mold-On Rubber	8
R90182A1412	24 x 48	Mold-On Rubber	8
R90184A1411	24 x 48	Polyolefin	8
R90184A1412	24 x 48	Polyolefin	8
R90185A1411	24 x 48	Thermoplastic	8
R90185A1412	24 x 48	Thermoplastic	8
R90165A1411	24 x 48	Easy-Roll	6
R90165A1412	24 x 48	Easy-Roll	6
R90210A1011	30 x 60	Pneumatic	10
R90210A1012	30 x 60	Pneumatic	10
R90262A1011	30 x 60	Polyolefin	6
R90262A1012	30 x 60	Polyolefin	6
R90263A1011	30 x 60	Polyurethane	6
R90263A1012	30 x 60	Polyurethane	6
R90281A1011	30 x 60	Pneumatic	8
R90281A1012	30 x 60	Pneumatic	8
R90282A1011	30 x 60	Mold-On Rubber	8
R90282A1012	30 x 60	Mold-On Rubber	8
R90284A1011	30 x 60	Polyolefin	8
R90284A1012	30 x 60	Polyolefin	8
R90285A1011	30 x 60	Thermoplastic	8
R90285A1012	30 x 60	Thermoplastic	8
R90265A1011	30 x 60	Easy-Roll	6
R90265A1012	30 x 60	Easy-Roll	6

Note: Models ending in "11" have open handles, those ending in "12" have crossbar handles.

**Handle Style "B"**

2 Crossbar Swayback

Style "B" – 2 Crossbar Swayback

Model No.	Deck Size	Caster Type	Caster Size (In.)
R90110B2412	24 x 48	Pneumatic	10
R90181B2412	24 x 48	Pneumatic	8
R90182B2412	24 x 48	Mold-On Rubber	8
R90184B2412	24 x 48	Polyolefin	8
R90165B2412	24 x 48	Easy-Roll	6
R90210B2012	30 x 60	Pneumatic	10
R90281B2012	30 x 60	Pneumatic	8
R90282B2012	30 x 60	Mold-On Rubber	8
R90284B2012	30 x 60	Polyolefin	8
R90265B2012	30 x 60	Easy-Roll	6

**Handle Style "D"**

3 Open Straight

Style "D" – 3 Open Straight Length of Deck

Model No.	Deck Size	Caster Type	Caster Size (In.)
R90162D3815	24 x 48	Polyolefin	6
R90163D3815	24 x 48	Polyurethane	6
R90181D3815	24 x 48	Pneumatic	8
R90182D3815	24 x 48	Mold-On Rubber	8
R90262D3015	30 x 60	Polyolefin	6
R90263D3015	30 x 60	Polyurethane	6
R90281D3015	30 x 60	Pneumatic	8
R90282D3015	30 x 60	Mold-On Rubber	8

**Handle Style "S"**

2 Open Swayback & 4
Wire Mesh Side Panels

Style "S" – 2 Open Swayback & 4 Wire Mesh Side Panels

Model No.	Deck Size	Caster Type	Caster Size (In.)
R90110S2411	24 x 48	Pneumatic	10
R90181S2411	24 x 48	Pneumatic	8
R90182S2411	24 x 48	Mold-On Rubber	8
R90184S2411	24 x 48	Polyolefin	8
R90165S2411	24 x 48	Easy-Roll	6
R90210S2011	30 x 60	Pneumatic	10
R90281S2011	30 x 60	Pneumatic	8
R90282S2011	30 x 60	Mold-On Rubber	8
R90284S2011	30 x 60	Polyolefin	8
R90265S2011	30 x 60	Easy-Roll	6

**Handle Style "P"**

1 High Side Rail &
1 Low Side Rail

Style "P" – 1 High Side Rail & 1 Low Side Rail

Model No.	Deck Size	Caster Type	Caster Size (In.)
R90162P24111811	24 x 48	Polyolefin	6
R90163P24111811	24 x 48	Polyurethane	6
R90181P24111811	24 x 48	Pneumatic	8
R90182P24111811	24 x 48	Mold-On Rubber	8
R90262P20111011	30 x 60	Polyolefin	6
R90263P20111011	30 x 60	Polyurethane	6
R90281P20111011	30 x 60	Pneumatic	8
R90282P20111011	30 x 60	Mold-On Rubber	8

**Handle Style "F"**

4 Corner Posts - 39" tall

Style "F" – 4 Corner Posts

Model No.	Deck Size	Caster Type	Caster Size (In.)
R90110F44813	24 x 48	Pneumatic	10
R90163F44813	24 x 48	Polyurethane	6
R90181F44813	24 x 48	Pneumatic	8
R90182F44813	24 x 48	Mold-On Rubber	8
R90184F44813	24 x 48	Polyolefin	8
R90210F40013	30 x 60	Pneumatic	10
R90263F40013	30 x 60	Polyurethane	6
R90281F40013	30 x 60	Pneumatic	8
R90282F40013	30 x 60	Mold-On Rubber	8
R90284F40013	30 x 60	Polyolefin	8

Brake and floor lock options available – consult Akro-Mils for your application needs.

ULTRA/Deck™

HEAVY-DUTY STRUCTURAL FOAM PLATFORM TRUCK



ULTRA/Deck™



UP TO
3000
LBS.

U90181A1412



FEATURES

- 1 Sturdy, easy-to-clean, non-skid structural foam deck resists most chemicals and damage from long-term weather exposure
- 2 The ULTRA/Deck is heavy-duty! Steel reinforcements and extra structural foam ribs under the deck add strength and stability for your toughest loads
- 3 Cart handles and rails feature a durable, powder-coated finish, and are removable for convenient shipping and storage

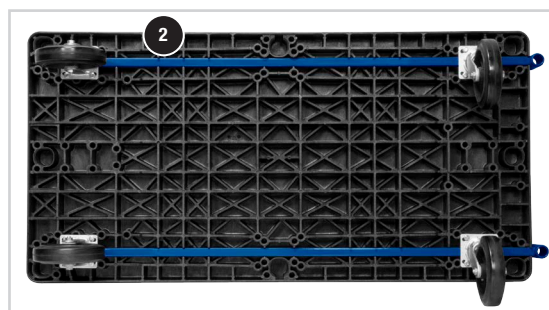

PRODUCT HIGHLIGHTS

- **RUGGED** – HDPE molded structural foam withstands the toughest loads in most environments
- **CAPACITY** – Caster options allow up to 3,000 lb. weight capacity
- **VARIETY** – Multiple handle, deck and caster options to select the exact configuration you need

Handle Styles:

Handle – Outside Deck



Open
Swayback



Crossbar
Swayback

Handle Rails – Indeck

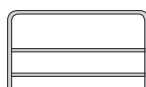

Crossbar
Straight

COLOR
Black/Blue



CASTER & WHEEL CHOICES

allow you to resolve problems of noise control, floor protection, impact or abrasion resistance, or load capacity. See page 89 for more information.



Mold-On Rubber



Pneumatic



Polyolefin



Polyurethane



Thermoplastic



Easy-Roll

**Handle Style "A"**

1 Crossbar Swayback
or
1 Open Swayback

Models ending in "11"
have open handles,
those ending in "12"
have crossbar handles

Style "A" – 1 Crossbar Swayback or 1 Open Swayback

Model No.	Deck Size	Caster Type	Caster Size (In.)
U90110A1411	24 x 48	Pneumatic	10
U90110A1412	24 x 48	Pneumatic	10
U90162A1411	24 x 48	Polyolefin	6
U90162A1412	24 x 48	Polyolefin	6
U90163A1411	24 x 48	Polyurethane	6
U90163A1412	24 x 48	Polyurethane	6
U90181A1411	24 x 48	Pneumatic	8
U90181A1412	24 x 48	Pneumatic	8
U90182A1411	24 x 48	Mold-On Rubber	8
U90182A1412	24 x 48	Mold-On Rubber	8
U90184A1411	24 x 48	Polyolefin	8
U90184A1412	24 x 48	Polyolefin	8
U90185A1411	24 x 48	Thermoplastic	8
U90185A1412	24 x 48	Thermoplastic	8
U90165A1411	24 x 48	Easy Roll	6
U90165A1412	24 x 48	Easy Roll	6
U90210A1011	30 x 60	Pneumatic	10
U90210A1012	30 x 60	Pneumatic	10
U90262A1011	30 x 60	Polyolefin	6
U90262A1012	30 x 60	Polyolefin	6
U90263A1011	30 x 60	Polyurethane	6
U90263A1012	30 x 60	Polyurethane	6
U90281A1011	30 x 60	Pneumatic	8
U90281A1012	30 x 60	Pneumatic	8
U90282A1011	30 x 60	Mold-On Rubber	8
U90282A1012	30 x 60	Mold-On Rubber	8
U90284A1011	30 x 60	Polyolefin	8
U90284A1012	30 x 60	Polyolefin	8
U90285A1011	30 x 60	Thermoplastic	8
U90285A1012	30 x 60	Thermoplastic	8
U90265A1011	30 x 60	Easy Roll	6
U90265A1012	30 x 60	Easy Roll	6

Note: Models ending in "11" have open handles, those ending in "12" have crossbar handles.

**Handle Style "B"**

2 Crossbar Swayback

Style "B" – 2 Crossbar Swayback

Model No.	Deck Size	Caster Type	Caster Size (In.)
U90110B2412	24 x 48	Pneumatic	10
U90181B2412	24 x 48	Pneumatic	8
U90182B2412	24 x 48	Mold-On Rubber	8
U90184B2412	24 x 48	Polyolefin	8
U90210B2012	30 x 60	Pneumatic	10
U90281B2012	30 x 60	Pneumatic	8
U90282B2012	30 x 60	Mold-On Rubber	8
U90284B2012	30 x 60	Polyolefin	8

**Handle Style "D"**

3 Crossbar Straight Index

Style "D" – 3 Crossbar Straight, Index

Model No.	Deck Size	Caster Type	Caster Size (In.)
U90162D3817	24 x 48	Polyolefin	6
U90163D3817	24 x 48	Polyurethane	6
U90181D3817	24 x 48	Pneumatic	8
U90182D3817	24 x 48	Mold-On Rubber	8
U90262D3017	30 x 60	Polyolefin	6
U90263D3017	30 x 60	Polyurethane	6
U90281D3017	30 x 60	Pneumatic	8
U90282D3017	30 x 60	Mold-On Rubber	8

**Handle Style "G"**

2 Crossbar Straight Index;
1 Open Swayback

Style "G" – 2 Crossbar Straight, Index; 1 Open Swayback

Model No.	Deck Size	Caster Type	Caster Size (In.)
U90110G14112817	24 x 48	Pneumatic	10
U90181G14112817	24 x 48	Pneumatic	8
U90182G14112817	24 x 48	Mold-On Rubber	8
U90184G14112817	24 x 48	Polyolefin	8
U90210G10112017	30 x 60	Pneumatic	10
U90281G10112017	30 x 60	Pneumatic	8
U90282G10112017	30 x 60	Mold-On Rubber	8
U90284G10112017	30 x 60	Polyolefin	8

**Handle Style "H"**

1 Crossbar Straight Index;
2 Crossbar Swayback

Style "H" – 1 Crossbar Straight, Index; 2 Crossbar Swayback

Model No.	Deck Size	Caster Type	Caster Size (In.)
U90162H24121817	24 x 48	Polyolefin	6
U90163H24121817	24 x 48	Polyurethane	6
U90181H24121817	24 x 48	Pneumatic	8
U90182H24121817	24 x 48	Mold-On Rubber	8
U90262H20121017	30 x 60	Polyolefin	6
U90263H20121017	30 x 60	Polyurethane	6
U90281H20121017	30 x 60	Pneumatic	8
U90282H20121017	30 x 60	Mold-On Rubber	8

**Handle Style "L"**

2 Crossbar Straight Index;
2 Open Swayback

Style "L" – 2 Crossbar Straight, Index; 2 Open Swayback

Model No.	Deck Size	Caster Type	Caster Size (In.)
U90110L24112817	24 x 48	Pneumatic	10
U90163L24112817	24 x 48	Polyurethane	6
U90181L24112817	24 x 48	Pneumatic	8
U90182L24112817	24 x 48	Mold-On Rubber	8
U90184L24112817	24 x 48	Polyolefin	8
U90210L20112017	30 x 60	Pneumatic	10
U90263L20112017	30 x 60	Polyurethane	6
U90281L20112017	30 x 60	Pneumatic	8
U90282L20112017	30 x 60	Mold-On Rubber	8
U90284L20112017	30 x 60	Polyolefin	8

Other handle and caster combinations available – consult Akro-Mils for your application needs.

Platform Trucks Work Height – Heavy-Duty

TUBULAR FRAME SUPPORTS HEAVIER LOADS



FEATURES

- 1 1½" 16-gauge tubular all-welded frame
- 2 Durable powder-coated finish
- 3 Deck options: kiln-dried tongue and groove hardwood, steel, structural foam
- 4 Fixed or adjustable height deck
- 5 Optional expanded metal or solid steel shelf



MADE IN USA



RWHV24481A5M8A



RWHS30601A5M8



RWHS30601A5M8

COLOR
Red



PRODUCT HIGHLIGHTS

- **ERGONOMIC** – Height reduces strain of lifting and bending
- **DURABLE** – Hardwood, steel or structural foam decks available
- **CAPACITY** – Up to 2,000 lb. weight capacity
- **VARIETY** – Fixed and adjustable heights available. Optional expanded metal shelf or solid steel lower shelf. Deck sizes: 24" x 48", 30" x 60"

ACCESSORIES



Corner Bumpers



Expanded Metal Shelf



Solid Metal Shelf



Floor Locks



Wheel Locks

Platform Trucks - Fixed Work Height - Tubular Steel Frame		Dimensions (In.)			Caster		
Model No.	Deck Type	L	W	H	Type*	Size (In.)	Weight Capacity (lbs.)
RWH24481A5M8	Wood	24	48	26-3/8	Mold-On Rubber	8	1800
RWHV24481A5M8	Structural Foam	24	48	26-7/8	Mold-On Rubber	8	1800
RWHV24481A5Y6	Structural Foam	24	48	24-7/8	Polyurethane	6	2000
RWHS24481A5M8	Steel	24	48	25-1/4	Mold-On Rubber	8	1800
RWHS24481A5Y6	Steel	24	48	23-1/4	Polyurethane	6	1800
RWH30601A5M8	Wood	30	60	26-3/8	Mold-On Rubber	8	1800
RWHV30601A5M8	Structural Foam	30	60	26-7/8	Mold-On Rubber	8	1800
RWHV30601A5Y6	Structural Foam	30	60	24-7/8	Polyurethane	6	2000
RWHS30601A5M8	Steel	30	60	25-1/4	Mold-On Rubber	8	1800
RWHS30601A5Y6	Steel	30	60	23-1/4	Polyurethane	6	1800

* See page 95 for full description of casters and wheels.

Platform Trucks - Adjustable Work Height - Tubular Steel Frame		Dimensions (In.)			Caster		
Model No.	Deck Type	L	W	H	Type*	Size (In.)	Weight Capacity (lbs.)
RWH24481A5M8A	Wood	24	48	26-3/4 to 32-3/4	Mold-On Rubber	8	1800
RWHV24481A5M8A	Structural Foam	24	48	27-1/2 to 33-1/2	Mold-On Rubber	8	1800
RWHV24481A5Y6A	Structural Foam	24	48	25-1/2 to 31-1/2	Polyurethane	6	2000
RWHS24481A5M8A	Steel	24	48	25-5/8 to 32	Mold-On Rubber	8	1800
RWHS24481A5Y6A	Steel	24	48	23-5/8 to 32	Polyurethane	6	1800
RWH30601A5M8A	Wood	30	60	26-3/4 to 32-3/4	Mold-On Rubber	8	1800
RWHV30601A5M8A	Structural Foam	30	60	27-1/2 to 33-1/2	Mold-On Rubber	8	1800
RWHV30601A5Y6A	Structural Foam	30	60	25-1/2 to 31-1/2	Polyurethane	6	2000
RWHS30601A5M8A	Steel	30	60	25-5/8 to 32	Mold-On Rubber	8	1800
RWHS30601A5Y6A	Steel	30	60	23-5/8 to 32	Polyurethane	6	1800

* See page 95 for full description of casters and wheels.

Platform Trucks Work Height – Standard-Duty : Skids

MORE STORAGE & TRANSPORT OPTIONS



Platform Trucks Work Height

STANDARD DUTY

FEATURES

- 1 1½" x 1½" x 1/8" all-welded angle iron frame
- 2 Durable powder-coated finish
- 3 Deck options: kiln-dried tongue and groove hardwood, steel or structural foam with tie-down slots
- 4 Fixed or adjustable height deck
- 5 Optional expanded metal or solid steel shelf



PRODUCT HIGHLIGHTS

- **ERGONOMIC** – Height reduces strain of lifting and bending
- **VARIETY** – Fixed and adjustable heights available. Optional expanded metal shelf. Deck sizes: 24" x 48", 30" x 60"

COLOR
Red



ACCESSORIES



Corner Bumpers



Floor Locks



Expanded Metal Shelf



Wheel Locks



Solid Metal Shelf

Platform Trucks - Fixed Work Height - Angle Iron Frame		Dimensions (In.)			Caster		
Model No.	Deck Type	L	W	H	Type*	Size* (Inches)	Weight Capacity (lbs.)
RWH2448EA5M6	Wood	24	48	24-1/2	Mold-On Rubber	6	1500
RWHV2448EA5M6	Structural Foam	24	48	24-7/8	Mold-On Rubber	6	1500
RWHS2448EA5M6	All-Steel	24	48	22	Mold-On Rubber	6	1500
RWH3060EA5M6	Wood	30	60	24-1/2	Mold-On Rubber	6	1500
RWHV3060EA5M6	Structural Foam	30	60	24-7/8	Mold-On Rubber	6	1500
RWHS3060EA5M6	All-Steel	30	60	22	Mold-On Rubber	6	1500

* See page 95 for full description of casters and wheels.

Platform Trucks - Adjustable Work Height - Angle Iron Frame		Dimensions (In.)			Caster		
Model No.	Deck Type	L	W	H	Type*	Size* (Inches)	Weight Capacity (lbs.)
RWH2448EA5M6A	Wood	24	48	24-1/2 to 30-1/2	Mold-On Rubber	6	1500
RWHV2448EA5M6A	Structural Foam	24	48	24-7/8 to 30-7/8	Mold-On Rubber	6	1500
RWHS2448EA5M6A	All-Steel	24	48	22 to 28	Mold-On Rubber	6	1500
RWH3060EA5M6A	Wood	30	60	24-1/2 to 30-1/2	Mold-On Rubber	6	1500
RWHV3060EA5M6A	Structural Foam	30	60	24-7/8 to 30-7/8	Mold-On Rubber	6	1500
RWHS3060EA5M6A	All-Steel	30	60	22 to 28	Mold-On Rubber	6	1500

* See page 95 for full description of casters and wheels.

Semi-Live Skids

TONGUE AND GROOVE HARDWOOD DECK

UP TO
2200
LBS.



- **EFFICIENT** – Can be used with a forklift or lift jack
- **VARIETY** – Deck sizes: 24" x 48", 30" x 60" (2 wheels standard)



Semi-Live Skids - 2 Wheels		Caster		
Model No.	Description	Type*	Size (In.)	Weight Capacity (lbs.)
RA778MR	Tongue & Groove Hardwood Deck	Mold-On Rubber	8	2200
RA756MR	Tongue & Groove Hardwood Deck	Mold-On Rubber	6	1800

Lift Jacks			Caster	
Model No.	Description	Handle Style	Type*	Size (In.)
RM718MR‡	Male Lift Jack	(T) or (Loop)	Mold-On Rubber	8
RF718MR‡	Female Lift Jack	(T) or (Loop)	Mold-On Rubber	8

* See page 95 for full description of casters and wheels. ‡ - Specify Handle Style (T) or (Loop) when ordering.

ProCart™

VERSATILE STRUCTURAL FOAM UTILITY CART

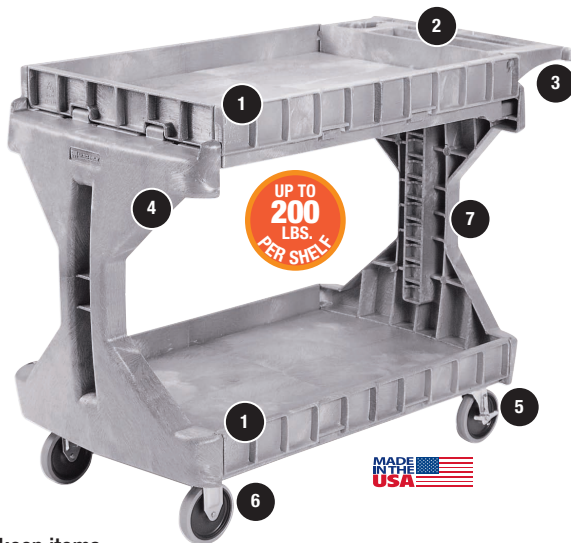

FEATURES

- 1 Hinged side gates on both shelves flip up or down to easily convert the ProCart to a flat-top or box-top cart
- 2 Deep, molded-in compartments keep items within reach (Only large cart has cup holder)
- 3 Comfortable, full-width handle gives complete handling control
- 4 Smooth, rounded corners and edges
- 5 Toe-touch, locking rear swivel wheels
- 6 Durable, non-marking, polyurethane on polyolefin 5" wheels: 1.75" x 3" caster bolt pattern
- 7 I-beam post makes loading and unloading oversized boxes on the lower shelf easy
- 8 Optional rail systems (sold separately) allow AkroBins®, Super Modular Cabinets or 19-Series Steel Cabinets to hang on cart



COLOR
Gray

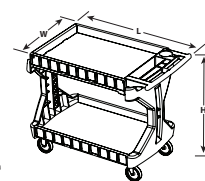

ProCart™

ProCart		Dimensions (In.)			Ctn. Qty.
Model No.	Description	L	W	H	
A30936	Large Cart	45-5/8	24	34-3/4	1
A30930	Small Cart	41-1/2	19	34-3/4	1

ProCart Rail Kits	
Model No.	Description
A30900	Small Cart 9-Rail System
A30906	Large Cart 9-Rail System
A30902	Large Cart 2-Rail System for Super Modular Cabinets

Easy assembly – requires Phillips screwdriver and rubber mallet.

PRODUCT HIGHLIGHTS

- **VERSATILE** – All-purpose utility cart for the assembly line, warehouse or wherever you need portable storage
- **DURABLE** – High-density structural foam construction is dent-resistant, rust-proof and never needs painting
- **CAPACITY** – 400 lb. maximum cart load. 200 lb. capacity per top and bottom shelf
- **ASSEMBLY** – Light assembly required
- **VARIETY** – 2 sizes

AkroBins Ordering Information

To create a customized ProCart with AkroBins, use the chart below to determine the quantity of bins that will fit your ProCart. Carts, rail kits and bins must be ordered separately. When ordering, please specify color. See pages 4-5 for more information.

Use this chart when ordering one size AkroBins and 19-Series Cabinets for your ProCart

Bin Model No. Bin Dim. L x W x H	A30210 5-3/8 x 4-1/8 x 3	A30220 7-3/8 x 4-1/8 x 3	A30224 10-7/8 x 4-3/16 x 4	A30230 10-7/8 x 5-1/2 x 5	A30234 14-3/4 x 5-1/2 x 5	A30235 10-3/8 x 11 x 5	A30239 10-3/4 x 8-1/4 x 7	A30240 14-3/4 x 8-1/4 x 7	A30250 14-3/4 x 16-1/2 x 7	A30255 7-10-3/4 x 16-1/2 x 5	A30320 8-5/8 x 33 x 5	19-Series Cabinet*
A30936 Large Cart	80	80	48	36	36	18	16	16	8	12	6	4
A30930 Small Cart	70	70	42	30	–	12	12	–	–	–	–	2

*Requires A98400 Suspension Straps for hanging.

RELATED PRODUCTS

Increase the benefits of your ProCart with



4-5 AkroBins



26 Akro-Grids



48 19-Series Steel Cabinets



57 Super Modular Cabinets

TiltView® Stack Cart

THE CONVENIENCE OF TILT-OUT BINS WITH A MOBILE CART



FEATURES

- 1 Handles located at each cart end for transport convenience
- 2 Fully assembled cart includes 3-Bin, 4-Bin and 5-Bin TiltView cabinets
- 3 Quiet, 3" non-marking thermo-plastic rubber swivel casters with total lock brakes
- 4 Padded corner bumpers to protect walls and doorways from damage

PRODUCT HIGHLIGHTS

- **DURABLE** – Carts made of 16-gauge powder-coated steel
- **CAPACITY** – 250-lb. weight capacity (100 lbs. each side; 50 lbs. top)



TiltView Stack Cart			Dimensions (In.)			Total Bin Cups
Model No.	Description	Cart Color	L	W	H	
TVSTACKCART	Cart with (2) 3 bin, (4) 4-bin and (2) 5-bin TiltView Cabinets	Beige	25-1/2	18-1/2	39-1/2	32

COLOR
Beige



TiltView Bins		Dimensions (In.)			Dividers
Model No.	Description	L	W	H	
A06703	3-Bin TiltView	7-7/8	23-5/8	9-7/16	A40703 (3/Pk)
A06704	4-Bin TiltView	6-3/4	23-5/8	8-3/16	A40704 (4/Pk)
A06705	5-Bin TiltView	5-3/8	23-5/8	6-1/2	-

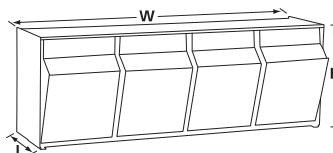

Louvered Carts

MOBILE WORKSTATION GETS SUPPLIES WHERE THEY ARE NEEDED



UP TO
800
LBS.



COLORS

Textured Charcoal Gray, Textured Putty



MADE
IN THE
USA

FEATURES

- 1 Welded steel frame
- 2 Tubular push handle on end of cart for easy handling
- 3 Louvered panels on cart end accommodate various sizes of hanging bins
- 4 Steel-reinforced butcher block work surface
- 5 Raised barriers near shelf edges keep AkroDrawers from sliding out when cart is in motion
- 6 2 rigid casters, 2 swivel casters with total lock brakes



PRODUCT HIGHLIGHTS

- **VERSATILE** – Industrial-grade mobile workstation
- **DURABLE** – Made from 16-gauge steel with a durable powder-coated finish
- **CAPACITY** – Non-marking blue elastic rubber casters allow a weight capacity of 800 lbs.
- **NO ASSEMBLY** – Ships fully assembled and ready to use
- **VARIETY** – 2 worktop sizes: 48" L x 24" W, and 36" L x 18" W. Colors: Textured Charcoal Gray, Textured Putty

Small Louvered Cart 37" L x 18" W x 36" H			Capacity/Qty.		
Model No.	Description	Cart Color	Wt. Capacity (lbs.)	Qty. of Drawers	Drawer Color
MA3618C MA3618P	Small Louvered Cart with no AkroDrawers	Textured Charcoal Gray Textured Putty	800	–	–
MA3618C1 MA3618P1	Small Louvered Cart with A31118 AkroDrawers	Textured Charcoal Gray Textured Putty	800	6	R,B,Y,GRY,CRY B,CRY
MA3618CAST MA3618PAST	Small Louvered Cart with A31168 & A31188 AkroDrawers	Textured Charcoal Gray Textured Putty	800	12 / 4	R,B,Y,GRY,CRY B,CRY

Specify drawer color when ordering: Red, Blue, Yellow, Gray or Crystal Clear available with Gray Cart. Blue or Crystal Clear available with Putty Cart. Only one color per unit.

Large Louvered Cart 49" L x 24" W x 37½" H			Capacity/Qty.		
Model No.	Description	Cart Color	Wt. Capacity (lbs.)	Qty. of Drawers	Drawer Color
MA4824C MA4824P	Large Louvered Cart with no AkroDrawers	Textured Charcoal Gray Textured Putty	800	–	–
MA4824C1 MA4824P1	Large Louvered Cart with A31142 & A31162 AkroDrawers	Textured Charcoal Gray Textured Putty	800	22 / 16	R,B,Y,GRY,CRY B,CRY
MA4824C2 MA4824P2	Large Louvered Cart with A31142 & A31182 AkroDrawers	Textured Charcoal Gray Textured Putty	800	22 / 10	R,B,Y,GRY,CRY B,CRY
MA4824C3 MA4824P3	Large Louvered Cart with A31112 AkroDrawers	Textured Charcoal Gray Textured Putty	800	16	R,B,Y,GRY,CRY B,CRY

Specify drawer color when ordering: Red, Blue, Yellow, Gray or Crystal Clear available with Gray Cart. Blue or Crystal Clear available with Putty Cart. Only one color per unit.

AkroDrawers®

AkroDrawers	Outside Dimensions (in.)			
	Model No.	L	W	H
A31142	11-5/8	3-3/4	4-5/8	
A31148	17-5/8	3-3/4	4-5/8	
A31162	11-5/8	5-9/16	4-5/8	
A31182	11-5/8	8-3/8	4-5/8	
A31164	23-7/8	5-9/16	4-5/8	
A31168	17-5/8	5-9/16	4-5/8	
A31188	17-5/8	8-3/8	4-5/8	
A31112	11-5/8	11-1/8	4-5/8	
A31118	17-5/8	11-1/8	4-5/8	

Locking Louvered Carts

LOCKABLE MOBILE WORKSTATION



NEW!

UP TO
800
LBS.



MA3618PLD



MA4824PLD

COLORS

Textured Charcoal Gray,
Textured Putty, Textured Black



FEATURES

- 1 Tubular push handle on end of cart for easy handling
- 2 Steel-reinforced butcher block work surface
- 3 Generous 6.5 cu. ft. of lockable storage space offers room to secure larger bulky items - power tools, expensive equipment, medical supplies and more
- 4 Raised barriers near shelf edges keep AkroDrawers from sliding out when cart is in motion
- 5 2 rigid casters, 2 swivel casters with total lock brakes

PRODUCT HIGHLIGHTS

- **VERSATILE** – Industrial-grade mobile workstation with a welded 16-gauge steel frame
- **SECURE** – Lockable doors with flush mount keyed handle
- **CAPACITY** – Non-marking blue elastic rubber casters allow a weight capacity of 800 lbs.
- **NO ASSEMBLY** – Ships fully assembled and ready to use
- **VARIETY** – 2 worktop sizes: 48" L x 24" W, and 36" L x 18" W. Colors: Textured Charcoal Gray, Textured Putty, Textured Charcoal

Small Louvered Cart with Locking Doors 37" L x 18" W x 36" H			Capacity/Qty.		
Model No.	Description	Cart Color	Wt. Capacity (lbs.)	Qty. of Drawers	Drawer Color
MA3618CLD MA3618BLD MA3618PLD	Small Locking Louvered Cart with no AkroDrawers	Textured Charcoal Gray Textured Black Textured Putty	800	–	–
MA3618CLD1 MA3618BLD1 MA3618PLD1	Small Locking Louvered Cart with A31118 AkroDrawers	Textured Charcoal Gray Textured Black Textured Putty	800	6	R,B,Y,GRY,CRY R,B,Y,GRY,CRY B,CRY

Specify drawer color when ordering: Red, Blue, Yellow, Gray or Crystal Clear available with Gray or Black Carts. Blue or Crystal Clear available with Putty Carts. Only one color per unit.

Large Louvered Cart with Locking Doors 49" L x 24" W x 37½" H			Capacity/Qty.		
Model No.	Description	Cart Color	Wt. Capacity (lbs.)	Qty. of Drawers	Drawer Color
MA4824CLD MA4824BLD MA4824PLD	Large Locking Louvered Cart with no AkroDrawers	Textured Charcoal Gray Textured Black Textured Putty	800	–	–
MA4824CLD1 MA4824BLD1 MA4824PLD1	Large Locking Louvered Cart with A31142 & A31162 AkroDrawers	Textured Charcoal Gray Textured Black Textured Putty	800	22 / 16	R,B,Y,GRY,CRY R,B,Y,GRY,CRY B,CRY
MA4824CLD2 MA4824BLD2 MA4824PLD2	Large Locking Louvered Cart with A31142 & A31182 AkroDrawers	Textured Charcoal Gray Textured Black Textured Putty	800	22 / 10	R,B,Y,GRY,CRY R,B,Y,GRY,CRY B,CRY
MA4824CLD3 MA4824BLD3 MA4824PLD3	Large Locking Louvered Cart with A31112 AkroDrawers	Textured Charcoal Gray Textured Black Textured Putty	800	16	R,B,Y,GRY,CRY R,B,Y,GRY,CRY B,CRY

Specify drawer color when ordering: Red, Blue, Yellow, Gray or Crystal Clear available with Gray or Black Carts. Blue or Crystal Clear available with Putty Carts. Only one color per unit.

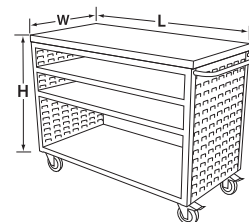

Shelf Carts

HEAVY-DUTY CARTS ARE DESIGNED FOR DAILY WORK



UP TO
2200
LBS.



Shelf Options



Lips Down - standard



Lips Up - add "LU" to end of Model No.

FEATURES

- 1 Heavy-duty, 13-gauge welded steel frame and shelves
- 2 Models feature 1½" lips down shelves
- 3 Variety of bolt-on casters available
- 4 Swayback, vertical and horizontal tubular push handles available

PRODUCT HIGHLIGHTS

- **DURABLE** – Made from 13-gauge steel with a durable powder-coated finish
- **CAPACITY** – Built to withstand loads up to 2,200 lbs. with recommended casters
- **NO ASSEMBLY** – Ships fully assembled and ready to use
- **VARIETY** – Cart sizes: 24" x 36", 24" x 48", 30" x 48", 30" x 60". Choose from several caster options as well as rubber matting, a writing shelf and drawers

COLOR
Gray



ACCESSORIES



Drawer



Writing Shelf

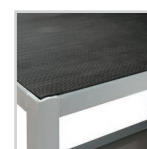

Rubber Matting



Wheel Locks

Handle Options



Swayback



Horizontal Tubular



Vertical

Shelf Carts						
Model No. Lips Down*	Height (In.)	No. of Shelves	Shelf Clearance (In.)	Caster Type	Handle Style	Weight Capacity (lbs.)
R1S8FP2	33-1/2	2	20-3/4	8" Full Pneumatic	Swayback	1200
R1S10FP2	35-1/4	2	20-3/4	10" Full Pneumatic	Swayback	1200
R1S5HR	30	2	20-3/4	5" x 2" Polyolefin	Vertical	1800
R1S5HR2LD	25	2	15-1/2	5" x 2" Polyolefin	Swayback	1800
R1S8MR	33	2	20-3/4	8" x 2" Mold-On Rubber	Vertical	2200
R1S8MR2	33	2	20-3/4	8" x 2" Mold-On Rubber	Swayback	2200
R2S5HR	30	2	20-3/4	5" x 2" Polyolefin	Horiz. Tubular	1800
R3S5HR	30	3	9-5/8	5" x 2" Polyolefin	Horiz. Tubular	1800
R4S5HR	63-1/4	4	17	5" x 2" Polyolefin	Horiz. Tubular	1800
R4S8MR	66-1/4	4	17	8" x 2" Mold-On Rubber	Horiz. Tubular	2200
R5S5HR	63-1/4	5	12-1/2	5" x 2" Polyolefin	Horiz. Tubular	1800
R5S8MR	66-1/4	5	12-1/2	8" x 2" Mold-On Rubber	Horiz. Tubular	2200

Specify shelf size and lips up or lips down when ordering. *Standard shelves are lips down, to order lips up, add "LU" to the end of the Model Number.



SystemBins™

System Bin Multi-Shelf Carts	Dimensions (In.)			No. of Shelves	Caster Type	Handle (In.)	Bin/Qty.	Color	Weight Capacity (lbs.)
	L	W	H						
R5SYT5HR2436	36	24-1/2	40	5	5" x 2" Polyolefin	Horiz. Tubular	A30312 / 10*	R, Y, B	1800
R5SYT8MR2436	36	24-1/2	43	5	8" x 2" Mold-On Rubber	Horiz. Tubular	A30312 / 10*	R, Y, B	2200
R5SYT5HR3636	36	36-1/2	40	5	5" x 2" Polyolefin	Horiz. Tubular	A30318 / 10**	R, Y, B	1800
R5SYT8MR3636	36	36-1/2	43	5	8" x 2" Mold-On Rubber	Horiz. Tubular	A30318 / 10**	R, Y, B	2200

Bin color code: R=Red, B=Blue, Y=Yellow. Specify bin color when ordering. *Qty. of A30312 System Bins included. **Qty. of A30318 System Bins included.

Box Trucks : Tray Service Carts : Super-Size AkroBin® Carts

HEAVY-DUTY MOBILE CARTS FOR HEAVY, BULKY ITEMS



UP TO
1800
LBS.

R1B5HRXL



Box Trucks

- **DURABLE** – Made from 13-gauge all-welded steel with 2" hemmed edges or #13 expanded metal in 1½" x 1½" x 1/8" angle frame
- **CAPACITY** – 1,800 lb. weight capacity. Steel Box dimensions: 30½" overall height, 24" interior depth; Expanded Metal Box dimensions: 31½" overall height, 25" interior depth
- **CASTERS** – All box trucks have 2 swivel, 2 rigid, 5" x 2" polyolefin casters (additional caster types available)
- **SECURE** – Lids can be secured with padlock or combination lock
- **VARIETY** – Solid steel or expanded metal sides available. Box sizes: 24" x 36", 24" x 48", 30" x 36", 30" x 48". Available with optional lid



COLOR
Gray



CASTERS & WHEELS

Caster & Wheel choices allow you to resolve problems of noise control, floor protection, impact or abrasion resistance, or load capacity. See page 89 for more caster information.

Box Trucks				
Model No.	Description	Caster Type	Weight Capacity (lbs.)	
R1B5HR	Solid Steel Box Truck	5" Polyolefin	1800	
R1B5HRL	Solid Steel Box Truck with Lid	5" Polyolefin	1800	
R1B5HRX	Expanded Metal Box Truck	5" Polyolefin	1800	
R1B5HRXL	Expanded Metal Box Truck with Lid	5" Polyolefin	1800	

Tray Service Cart

- **EFFICIENT** – Excellent for library, manufacturing and food service operations
- **DURABLE** – 13-gauge all-welded steel construction features 12" deep tray and 12½" clear shelf spacing with 1½" lip
- **CASTERS** – 2 swivel, 2 fixed
- **HANDLE** – Tubular push handle for easy handling
- **VARIETY** – Standard sizes include 18" x 30", 24" x 36", 24" x 48"; optional size: 18" x 36"



R2T5HR1830



UP TO
2200
LBS.

COLOR
Gray



Tray Service Cart					
Model No.	Dimensions (In.)			Caster Type	Weight Capacity (lbs.)
	L	W	H		
R2T5HR1830	18	30	32-1/2	5" Polyolefin	1800
R2T5HR2436	24	36	32-1/2	5" Polyolefin	1800
R2T5HR2448	24	48	32-1/2	5" Polyolefin	1800
R2T8MR2448	24	48	35-1/2	8" Mold-On Rubber	2200

Super-Size AkroBin® Carts

UP TO
1500
LBS.



R214CS1878 shown with RSSAKBINHDDWN12

COLOR
Gray



- **MOBILE** – Mobilize your Super-Size AkroBins
- **EFFICIENT** – Easy organization of bulky parts
- **DURABLE** – Made from 11-gauge steel
- **CAPACITY** – Heavy-duty frames with weight capacities from 900 to 1,500 lbs.
- **VARIETY** – 4, 6, 9, 12 and 16-bin configurations (Super-Size AkroBins sold separately). Carts have 5" x 2" polyolefin casters. Optional security bar locks bins in place

Super-Size AkroBin Steel Carts				Dimensions (In.)			Accessories		Capacity/Qty.	
Model No.	Bin Compatibility	L	W	H	No. of Handles	Security Bar	Capacity (lbs.)		Ctn. Qty.	
							Capacity (lbs.)	Ctn. Qty.		
R214CS1841	Six A30283 Bins	41	18	48	2	RSSAKBINHDDWN6	900	1	1	
R214CS1859	Nine A30283 Bins	59	18	48	2	RSSAKBINHDDWN9	1350	1	1	
R214CS1878	Twelve A30283 Bins	78	18	48	2	RSSAKBINHDDWN12	1500	1	1	
R214CS2841	Six A30290 Bins	41	27-1/2	48	2	RSSAKBINHDDWN6	900	1	1	
R214CS2859	Nine A30290 Bins	59	27-1/2	48	2	RSSAKBINHDDWN9	1350	1	1	
R214CS2878	Twelve A30290 Bins	78	27-1/2	48	2	RSSAKBINHDDWN12	1500	1	1	
R216CS2236	Sixteen A30284 Bins or six A30286 Bins or six A30287 Bins or four A30288 Bins	35-1/2	22-1/8	35	1	–	900	1	1	
R216CS2836	Six A30292 Bins or four A30293 Bins	35-1/2	28-1/8	35	1	–	900	1	1	
R216CS2239	Four A30289 Bins	35-1/2	22-1/8	39	1	–	900	1	1	

Optional security bar available for all sizes. Bins sold separately.

Portable Tables & Carts : Mobile Work Tables

VERSATILE MOBILE SYSTEMS & WORK CENTERS

Portable Tables & Carts

- **VERSATILE** – Carts are ideal for stock picking, assembly operations or other heavy-duty tasks
- **DURABLE** – All-welded, 16-gauge steel construction. Gray powder-coated finish. Angle posts for added strength. Ships fully assembled!
- **CASTERS** – 2 swivel, 2 rigid 5" x 1 1/4" soft rubber casters for quiet and smooth maneuverability
- **DRAWER** – High-quality storage drawer is padlock-ready
- **VARIETY** – 2 sizes. Optional drawer, writing shelf, rubber shelf matting or wheel locks are available (sold separately)

Portable Tables							
Model No.	Cart Size (In.)	Height (In.)	No. of Shelves	Shelf Clearance (In.)	Caster Type	Handle Style	Weight Capacity (lbs.)
RMD2ST5SR	24 x 36	36	2	27	Soft Rubber	Tubular	800
RMD3ST5SR	24 x 36	36	3	12-1/2	Soft Rubber	Tubular	800



UP TO
800
LBS.

COLOR
Gray



Mobile Work Tables – Heavy-Duty

- **MULTI-SHELF** – Includes 21" D x 36" W bottom shelf; 13 1/2" D x 37" W tilted shelf for easy access to bins
- **DURABLE** – Industrial-grade mobile workstation with a welded-steel frame and steel-reinforced premium oak top. Gray powder-coated finish. Ships fully assembled!
- **ADJUSTABLE** – 24" L x 48" W work area with 9 adjustable height settings from 36" to 48"
- **WOOD TOP** – Kiln-dried hardwood work surface extends 2" to accommodate vise or clamps; wood top is premium oak boards with rounded edges 2 1/4" in overall thickness; individual planks are 1 1/8" (5/4); optional butcher block top available
- **CASTERS** – 5" x 2" bolted-on polyurethane casters; 2 rigid, 2 swivel with total lock brakes

Mobile Work Tables - Heavy-Duty		Dimensions (In.)			Caster		
Model No.	Deck Type	L	W	H	Type	Size (In.)	Weight Capacity (lbs.)
RHWB2448P5PY0G	Oak Hardwood	24	48	36 to 48	Polyurethane	5 x 2	800

COLOR
Gray



UP TO
800
LBS.



Mobile Work Tables – Medium-Duty

- **DURABLE** – Industrial-grade mobile workstation with a welded-steel frame and steel-reinforced tongue and groove hardwood top. Gray powder-coated finish. Ships fully assembled!
- **CASTERS** – 2 bolted-on non-marking thermo-plastic soft rubber casters; 2 swivel 5" x 1 1/4" casters with total lock brakes
- **DRAWERS** – 2 padlock-ready steel drawers: 15 3/4" W x 6 3/4" H x 20" D

Mobile Work Tables - Medium-Duty		Dimensions (In.)			Caster		
Model No.	Deck Type	L	W	H	Type	Size (In.)	Weight Capacity (lbs.)
RMWB24485SRTPG	Hardwood	24	48	36	Thermoplastic	5 x 1-1/4	800

COLOR
Gray



UP TO
800
LBS.





Heavy-Duty Work Benches

ADJUSTABLE & FIXED WORK HEIGHTS

FEATURES

- 11-gauge steel work surface extends 1½" on front and sides to accommodate a vise or clamps (hardwood extends 2')
- Wraparound steel backstop keeps items from falling behind work bench
- Adjustable work height telescoping C-channel legs provide a range of work heights from 30" to 40" (1½" increments)
- 12-gauge welded steel shelves
- 13½" deep middle shelf is sloped for easy access to bins or containers
- Anchor pads on each leg secure bench in a fixed position
- Durable powder-coated finish

PRODUCT HIGHLIGHTS

- DURABLE** – Heavy-duty steel frame work bench. Gray powder-coated finish.
- VARIETY** – Bench sizes: 30" x 60" and 30" x 72". Fixed or adjustable work heights. Steel, kiln-dried premium hardwood, butcher block or composition work surface. Work surface thickness: wood 2¼"; butcher block 1¾"; composition 1¾"



How to Order Your Work Bench

STEP 1

PICK A SIZE

Standard work table sizes:
30" x 60" • 30" x 72"

STEP 2

PICK FRAME COLOR (G)

Standard color:
Gray

STEP 3

PICK HEIGHT STYLE (F, A)

Fixed Height:
34" high

Adjustable Height:
30" - 40" high

STEP 4

PICK SHELF OPTIONS (1, 2, 3, 4)

- Option 1:**
Both shelves FORWARD, toward the front of the bench
- Option 2:**
Both shelves BACK, toward the back of the bench
- Option 3:**
Middle shelf FORWARD, bottom shelf BACK
- Option 4:**
Middle shelf BACK, bottom shelf FORWARD

STEP 4

PICK WORK SURFACE (S, P, B, C)

- Steel (S):**
11-gauge steel
- Hardwood (P):**
Premium kiln-dried hardwood 2¼" thick
- Butcher Block (B):**
1¾"
- Composition (C):**
1¾"

Call your Akro-Mils distributor with your model number today to order

model #	step 1	step 2	step 3	step 4	step 5
H-D Work Bench	Size	Frame Color	Height Style	Shelf Options	Work Surface
RHWB	3060	G (Gray)	F (Fixed)	1 (Both shelves forward) 2 (Both shelves back) 3 (Middle fwd, Bottom back) 4 (Middle back, Bottom fwd)	S (Steel) P (Hardwood) B (Butcher Block) C (Composition)
RHWB	3072	G (Gray)	A (Adjustable)	3	B
= RHWB3060GF3B					

Ships fully
assembled &
ready to use!



MADE
IN THE
USA

Hand Trucks

HEAVY-DUTY : MEDIUM-DUTY : GAS : CYLINDER



Heavy-Duty Hand Trucks

- **HEAVY-DUTY** – Hand trucks ideal for all types of loads
- **FRAME** – 1" OD structural pipe frame, 13-gauge steel
- **NOSE PLATE** – Standard 8" x 14" size. Optional 10" x 14" or 14" x 14" nose plate available, 7-gauge steel
- **WHEELS** – Two-position bracket fits 8" or 10" wheels
- **HANDLES** – Flow Back or Dual Loop handles



Medium-Duty Hand Trucks

- **FUNCTIONAL** – Hand trucks for day-to-day tasks
- **DURABLE** – Heavy-flat bar and tube for climbing stairs
- **FRAME** – 7/8" OD structural pipe frame, 13-gauge wall
- **NOSE PLATE** – Standard 7" x 14" size, 7-gauge steel
- **WHEELS** – Two-position bracket fits 8" or 10" wheels



4-Wheel Gas Cylinder Trucks

- **HEAVY-DUTY** – Designed to handle 330 cu. ft. cylinders
- **FRAME** – 1" OD structural pipe frame, 13-gauge wall
- **NOSE PLATE** – Standard 7" x 14" size, 7-gauge steel
- **WHEELS** – 4" polyolefin swivel casters



Standard Gas Cylinder Trucks

- **MEDIUM-DUTY** – Perfect for medium to large cylinders
- **VERSATILE** – Transports boxes or other bulky items
- **FUNCTIONAL** – Includes heavy-duty holding chain

COLOR

Gray



Heavy-Duty Hand Trucks - Flow Back			Dimensions (In.)	
Model No.	Wheel Type	Wheel Size (In.)	H	W
R4008MR	Mold-On Rubber	8	45	19-3/4
R4008MR2	Mold-On Rubber	8	52	19-3/4
R4010FP	Full Pneumatic	10	45	22
R4010FP2	Full Pneumatic	10	52	22
R4010SP	Semi-Pneumatic	10	45	20
R4010SP2	Semi-Pneumatic	10	52	22

Heavy-Duty Hand Trucks - Dual Loop			Dimensions (In.)	
Model No.	Wheel Type	Wheel Size (In.)	H	W
R4510SP	Semi-Pneumatic	10	46	20
R4510SP2	Semi-Pneumatic	10	53	20

COLOR

Gray



Medium-Duty Hand Trucks - Flow Back			Dimensions (In.)	
Model No.	Wheel Type	Wheel Size (In.)	H	W
R3008MR	Mold-On Rubber	8	45	19-5/8
R3010FP	Full Pneumatic	10	45	22
R3010SP	Semi-Pneumatic	10	45	20

COLOR

Green



4-Wheel Gas Cylinder Trucks				
Model No.	Truck Type	Wheel Type	Wheel Size (In.)	Base Plate
RGT510FP	Single	Full Pneumatic	10 x 3-1/2	14" W x 6" D, OAH – 45" 1143
RGTD10FP	Dual	Full Pneumatic	10 x 3-1/2	29" W x 6" D, OAH – 45" 1143
RGT510SP	Single	Semi-Pneumatic	10 x 2-3/4	14" W x 6" D, OAH – 45" 1143
RGTD10SP	Dual	Semi-Pneumatic	10 x 2-3/4	29" W x 6" D, OAH – 45" 1143

Single holds up to #4 (130 cu. ft.) acetylene or 336 cu ft high-pressure cylinder. Double holds up to two #4 (130 cu ft) acetylene or 251 cu ft high-pressure cylinders.

COLOR

Green



Standard Gas Cylinder Trucks				
Model No.	Description	Wheel Type	Wheel Size (In.)	Base Plate
RCT40LW	Dual with T-Handle	Plain Bore Plastic	8 x 1-3/4	17" W x 8" D, OAH – 43" 1092
RCTV40SP	Single	Semi-Pneumatic	10 x 2-3/4	14" W x 7" D, OAH – 48" 1219

Single holds up to #4 (130 cu. ft.) acetylene or 336 cu ft high-pressure cylinder. Double holds up to two #4 (130 cu ft) acetylene or 251 cu ft high-pressure cylinders.



Flow Back Handle (FB)



Dual Loop Handle



T-Handle

Dual-Purpose Hand Truck : Pail Truck

SPECIALTY HAND TRUCKS

Dual-Purpose Hand Truck

2-IN-1 CONVERTIBLE HAND TRUCK

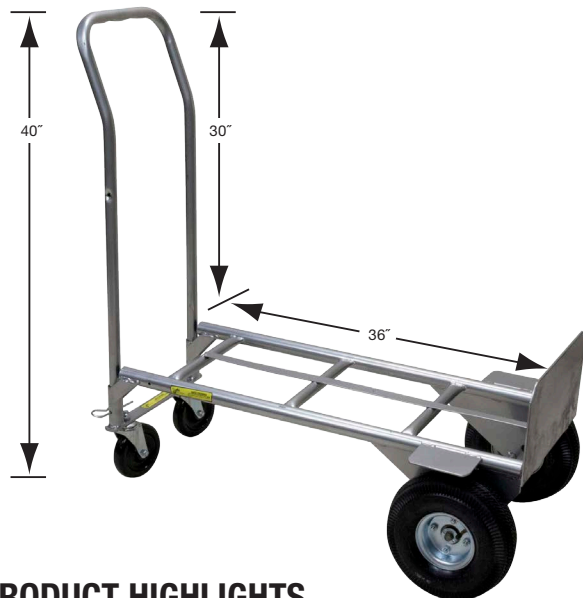

COLOR
Silver



PRODUCT HIGHLIGHTS

- **VERSATILE** – Dual-function hand truck converts to platform position for oversized loads
- **HEAVY-DUTY** – Welded, 1⁵/₁₆" OD tube frame and 1" OD tube handle powder-coated for durability
- **NOSE PLATE** – Standard 8" x 14" size
- **CAPACITY** – Holds up to 600 lbs. in platform mode

Dual-Purpose Hand Truck

Model No.	Wheel Type	Wheel/Caster Size (In.)	Overall Height (In.)	Overall Width (In.)
RDT4008SP	Semi-Pneumatic	8 / 3	46	19-5/8
RDT4010FP	Full Pneumatic	10 / 5	46	22
RDT4010SP	Semi-Pneumatic	10 / 5	46	20



Pail Truck

TRANSPORT 5-GALLON PAILS

PRODUCT HIGHLIGHTS

- **FUNCTIONAL** – Multi-purpose hand truck for carting 5-gallon pails
- **CAPACITY** – Holds 4 pails, up to 300 lbs. weight capacity

COLOR
Gray



Pail Truck

Model No.	Wheel Type	Wheel Size (In.)	Overall Height (In.)	Overall Width (In.)
RPT4010SP	Semi-Pneumatic	10	55-1/2	18-1/2



Akro-Tilt Trucks : Akro-Carts

BULK HANDLING & WASTE TRANSPORT SYSTEMS



Akro-Tilt Trucks

NEW Design

FEATURES

- NEW FEATURE!** Nests for shipping[†], saving on freight and space
- Wheel base and heavy-duty caster combination provides easy maneuverability even with heavy loads
- Forklift channels allow fully loaded Akro-Tilt Trucks to be moved and maneuvered by lift trucks, saving time, money and effort
- Powder-coated tubular frame, constructed of 1.05" O.D. x 13-gauge and 1.3125" O.D. x 13-gauge wall tubes, extends under top rim for added strength
- Fully welded, reinforced frame is optimized for automatic dumper applications
- Optional tow bar links carts together



A77710F

UP TO
2000
LBS.



Lid Model A77002

A full-width, heavy-duty piano hinge in the middle of the lid allows it to flip open during use.

COLOR**
Gray/Gray



Akro-Tilt Trucks				Dimensions (In.)			Lid	Wheels/Casters			Capacity				
Model No.	Model No. with Fork Channels	Model No. with Tow Bar	Model No. with Drain Plug ^S	Description	W	D	H	Model No.	Wheel Diameter	Wheel Type	Casters	Gal.	Cu. Yds.	Cu. Ft.	Load Rating
A77405GREY #	A77405FGREY #	A77405GREYTB #	A77405GREYDP #	Medium-Duty 100	29	51	38	-	12	SP	1-4"	100	½	13.5	600 lbs.
A77410GREY #**	A77410FGREY #**	A77410GREYTB #**	A77410GREYDP #**	Medium-Duty 200	33	66	42	A77002	12	SP	1-4"	200	1	27	600 lbs.
A77505GREY #	A77505FGREY #	A77505GREYTB #	A77505GREYDP #	Heavy-Duty 100	27	54	36	-	10	MR	1-4"	100	½	13.5	1000 lbs.
A77510GREY #**	A77510FGREY #**	A77510GREYTB #**	A77510GREYDP #**	Heavy-Duty 200	33	66	42	A77002	10	MR	1-4"	200	1	27	1000 lbs.
A77610GREY #**	A77610FGREY #**	A77610GREYTB #**	A77610GREYDP #**	Super-Heavy-Duty 200	33	66	42	A77002	12	MR	2-4"	200	1	27	2000 lbs.
A77710GREY	A77710FGREY	A77710GREYTB	A77710GREYDP	Heavy-Duty 300	39	85	51	-	12	MR	2-4"	300	1½	40.5	2000 lbs.
A77810GREY #**	A77810FGREY #**	A77810GREYTB #**	A77810GREYDP #**	Heavy-Duty 400	48	85	51	-	12	MR	2-4"	400	2	54	2000 lbs.

SP = Semi-Pneumatic MR = Mold-On Rubber †Base units only - forklift or tow bar options do not stack. **Blue or Black also available, requires premium lead time, other colors available as a custom product. #Available in Blue requires premium lead time. * Available in Black requires premium lead time. SDrain plug option requires premium lead time.

Akro-Carts

FEATURES

- Thick, rugged tub walls
- Latch bars extend around the frame for easy loading
- Medium-duty and heavy-duty styles
- Wide mouth and low profile for easy loading
- Swivel caster for easy maneuverability and handling
- Heavy-duty piano hinge allows lid to be propped open during use



A76591

UP TO
450
LBS.



COLORS

Blue/Gray, Green/Gray Gray/Gray



Akro-Carts			Dimensions (In.)			Wheels/Casters									Load Rating			
Model No. without Lid*	Model No. with Lid	Description	W	D	H	Wheel Size	Wheel Type	Caster	Frame	Load Rating								
A76460	A76461	Medium-Duty 60 Gal. Cap.	30-1/2	48	33-1/2	12" x 2"	Solid Rubber	3 x 1-1/4 Thermoplastic	1" O.D. x 16 ga. galvanized w/ 5/8" solid axle	300 lbs.								
A76490	A76491	Medium-Duty 90 Gal. Cap.	30-1/2	47	39-1/2	12" x 2"	Solid Rubber	3 x 1-1/4 Thermoplastic	1" O.D. x 16 ga. galvanized w/ 5/8" solid axle	350 lbs.								
A76590	A76591	Heavy-Duty 90 Gal. Cap.	30-1/2	47	39-1/2	10" x 2-3/4"	Semi-Pneumatic	4 x 2 Mold-on Rubber	1.05" O.D. x 13 ga. powder-coated w/ 5/8" solid axle	450 lbs.								

Please specify colors when ordering. For additional colors, call us. *Carts without lids cannot have lids added after production. Single units are shipped completely assembled. When multiple units are ordered, lids are shipped separately and require assembly.

Starcarts

BULK HANDLING & WASTE TRANSPORT SYSTEMS

Mini

- 3" all swivel threadguard casters
- Plated steel undercarriage

Mini	Inside Dimensions (In.)			Outside Dimensions (In.)			Wheels					
	Model No.	W	D	H	W	D	H	Pattern	Wheel Diameter	Bu.	Cu. Ft.	Cu. M.
TS100A	18	18	23	21	21	27	All Swivel	3	4	5	.14	200
TS105A	16	30	25	19	33	28	All Swivel	3	5	6	.17	200
TS350A	20	30	20	23	33	24	All Swivel	3	6	7	.20	200
TS108A	22	22	34	24	24	38	All Swivel	3	6	7	.20	200
TS110A	21	31	21	25	35	24	All Swivel	3	7	8	.23	300
TS115A	16	45	24	19	48	28	All Swivel	3	8	9	.25	300



TS110A

Regular

- 3" threadguard casters in diamond pattern
- Treated plywood undercarriage
- Models 125 L and 145 L lids available

Regular	Inside Dimensions (In.)			Outside Dimensions (In.)			Wheels					
	Model No.	W	D	H	W	D	H	Pattern	Wheel Diameter	Bu.	Cu. Ft.	Cu. M.
TS125A	23	35	25	27	39	30	Diamond	4	10	12	.34	400
TS135A	25	37	26	29	41	31	Diamond	4	12	15	.42	400
TS145A	26	38	28	31	43	33	Diamond	4	14	16	.45	400



TS125B

Heavy Duty

- 4" threadguard casters in diamond or corner pattern
- Treated plywood undercarriage
- Models 125 L and 145 L lids available. (145 L also fits 155 B)

Heavy Duty	Inside Dimensions (In.)			Outside Dimensions (In.)			Wheels					
	Model No.	W	D	H	W	D	H	Pattern	Wheel Diameter	Bu.	Cu. Ft.	Cu. M.
TS125B	23	35	25	27	39	31	Diamond or Corner	4	10	12	.34	800
TS135B	25	37	26	29	41	32	Diamond or Corner	4	12	15	.42	800
TS145B	26	38	28	31	43	34	Diamond or Corner	4	14	16	.45	800
TS155B	26	38	30	31	43	36	Diamond or Corner	4	15	19	.54	800



TS135A

Heavy Duty "Oversized"

- Tapered for Shipping and Storage
- 5" & 6" casters ensure maneuverability
- Treated plywood undercarriage
- Color: Grey
- The 160B and 180B come standard with 5" casters
- The 195B come standard with 6" casters

Oversized	Inside Dimensions (In.)			Outside Dimensions (In.)			Wheels					
	Model No.	W	D	H	W	D	H	Pattern	Wheel Diameter	Bu.	Cu. Ft.	Cu. M.
TS160B	30	54	25	35	59	32	Diamond or Corner	5	18	22	.62	800
TS180B	30	48	30	35	53	38	Diamond or Corner	5	19	24	.68	800
TS195B	36	72	33	42	78	42	Diamond or Corner	6	38	46	1.30	1600



TS160B

All dimensions shown are approximate in inches. All weights are approximate in pounds.

Starcarts : Econocarts, Scale & Elevated Carts

BULK HANDLING & WASTE TRANSPORT SYSTEMS



8 Bu. Econocarts

- New ribbed design
- Molded from black recycled plastic
- 2 1/2" all swivel casters

8 Bu. Econocart	Outside Dimensions (In.)			Wheels				
Model No.	W	D	H	Pattern	Wheel Diameter	Bu.	Cu. Ft.	Load Rating
TS111ECS	24 ^{1/2}	36 ^{1/2}	26	All Swivel	2 1/2	8	9	175



10 Bu. Econocarts

- Light duty tub made from black recycled plastic
- 3" all swivel casters
- Treated plywood base

10 Bu. Econocart	Inside Dimensions (In.)			Outside Dimensions (In.)			Wheels				
Model No.	W	D	H	W	D	H	Pattern	Wheel Diameter	Bu.	Cu. Ft.	Load Rating
TS125EC	23	35	25	27	39	29	All Swivel	3	10	12	200



Scale Carts

- 3" all swivel threadguard casters
- Powder coated steel base
- 250 lb. scale
- Tare weight adjustment
- Removable plastic container

Scale Carts	Inside Dimensions (In.)			Outside Dimensions (In.)			Wheels				
Model No.	W	D	H	W	D	H	Pattern	Wheel Diameter	Bu.	Cu. Ft.	Load Rating
TS300SC	16	30	16	19	33	29	All Swivel	3	4	5	
TS350SC	20	30	20	23	33	33	All Swivel	3	6	7	



Elevated Carts

- 3" all swivel threadguard casters
- Powder coated steel base
- Removable plastic container

Elevated Carts	Inside Dimensions (In.)			Outside Dimensions (In.)			Wheels				
Model No.	W	D	H	W	D	H	Pattern	Wheel Diameter	Bu.	Cu. Ft.	Load Rating
TS300E	16	30	16	19	33	28	All Swivel	3	4	5	200
TS350E	20	30	20	23	33	29	All Swivel	3	6	7	200



Starcarts

BULK HANDLING & WASTE TRANSPORT SYSTEMS

Easy Access

- 5" threadguard casters in diamond or corner pattern
- Treated plywood undercarriage
- Easy access sidewall

Easy Access Carts	Inside Dimensions (In.)			Outside Dimensions (In.)			Wheels					
	Model No.	W	D	H	W	D	H	Pattern	Wheel Diameter	Bu.	Cu. Ft.	Load Rating
TS150	26	38	29	31	43	36		Diamond or Corner	5	16	19	800
TS165B	27	41	32	31	46	39		Diamond or Corner	5	18	21	900
TS175B	27	41	42	31	46	49		Diamond or Corner	5	21	24	900
TS185B	27	58	32	31	63	39		Diamond or Corner	5	21	24	900



Heavy Duty Elevated

- 4" all swivel threadguard casters
- Powder coated steel frame
- Removable plastic body

H.D. Elevated	Inside Dimensions (In.)			Outside Dimensions (In.)			Wheels					
	Model No.	W	D	H	W	D	H	Pattern	Wheel Diameter	Bu.	Cu. Ft.	Load Rating
TS310E	23	35	10	27	39	29		All Swivel	4	4	5	800
TS320E	22	45	5	24	48	34		All Swivel	4	2	3	800
TS330E	22	45	15	24	48	36 1/2		All Swivel	4	7	9	1000



Doublewall

- 1000 B features
- 6" threadguard casters in diamond or corner pattern
- 1200 B features
- 6" threadguard casters in diamond pattern
- Treated plywood base

Doublewall	Inside Dimensions (In.)			Outside Dimensions (In.)			Wheels					
	Model No.	W	D	H	W	D	H	Pattern	Wheel Diameter	Bu.	Cu. Ft.	Load Rating
TS1000B	25	35	30	29	39	39		Diamond or Corner	6	12	15	800
TS1200B	30	49	29	32	52	37		Diamond	6	20	24	900



Jumbo

- 6" threadguard casters in diamond or corner pattern
- Recessed plywood undercarriage
- Easy access cut-out option (shown)

Jumbo	Inside Dimensions (In.)			Outside Dimensions (In.)			Wheels					
	Model No.	W	D	H	W	D	H	Pattern	Wheel Diameter	Bu.	Cu. Ft.	Load Rating
TS840B	40	60	28	44	62	38		Diamond or Corner	6	30	38	1200
TS850B	42	62	42	45	65	54		Diamond or Corner	6	48	60	1500





BULK HANDLING & WASTE TRANSPORT SYSTEMS

Ingredient Bins

- Provides storage, protection and easy movement of all your ingredients
- Choice of either a hinged lid (TS101 IB and TS103 IB) or sliding lid (TS105 IB) to suit your particular application
- Moulded of FDA approved polyethylene
- Smooth inside surface for easy cleaning
- 3" Heavy duty casters (2 fixed, 2 swivel) provide both stability and maneuverability

Ingredient Bins	Dimensions (In.)			Capacity				Lid
	Model No.	W	D	H	Cu. Ft.	Cu. M	Imp Gal	
TS101IB	12 ½	29	27	3.36	.10	21	95	Hinged
TS103IB	15	29	27	4.4	.12	28	127	Hinged
TS105IB	19	33	29	6	.17	45	205	Sliding



Industrial Step Stands

- Step up safely to out of reach items or surfaces
- Extra wide design for maximum stepping area
- Rubber feet grip floor for extra stability
- Non skid slip resistant surface
- Molded carrying handles (4 on TSS-1, 6 on TSS-2)
- Molded from LLDPE – Chemical resistant

Industrial Step Stands	Dimensions (In.)			Standard Colours	Load Rating
	Model No.	W	D		
TSS-1	28	20	13	Grey & Yellow	500
TSS-2	36	28	20	Grey & Yellow	500



Convertible Linen Truck

- Removable re-inforced plastic shelves drop down to create a secure gate
- 6" Heavy Duty Althane casters provide 1500 lbs. load capacity
- Smooth plastic design eliminates chance of linen snags
- There is no exposed metal to rust
- Seamless plastic provides a sanitary easy to clean surface
- Equipped with molded in handles for easy controlled movement
- Shipping weight 200 lbs.

Linen Truck	Capacity				Dimensions (In.)		
Model No.	Bu.	Cu. FT	Cu. Yrd.	Cu. M	W	D	H
TS1750B	37	46	1.75	1.33	48	28	73 ½



Bulk Storage Trucks

- Painted steel base
- 6" neoprene casters
- Easy access sidewall
- Heavy ribbing for maximum durability
- 1000 lbs. maximum load

Bulk Storage Trucks	Capacity				Dimensions (In.)		
Model No.	Bu.	Cu. FT	Cu. Yrd.	Cu. M	W	D	H
TS1700B	30	37	1.44	1.10	48	28	55
TS1800B	33	41	1.52	1.16	48	28	66

Next Generation Starcarts

- Combine a single wall body with double wall box-style lip for greater durability and maximum impact resistance
- The combination of poly core wheels and heavy duty casters ensure maximum rollability and manoeuvrability



N.G. Starcarts	Capacity				Dimensions (In.)			
Model No.	Bu.	Cu. FT	Cu. Yrd.	Cu. M	W	D	H	Load Rating
TS430B	14	16	0.6	0.46	31	48	34 ½	1000
TS750B	19	24	0.9	0.68	31 ½	60	35 ½	1000
TS770B	32	39	1.5	1.14	35 ½	72	40	1500



Storage Bins

BULK HANDLING & WASTE TRANSPORT SYSTEMS

S.O.S Bins

- Roto molded of LLDPE
- Impact resistant
- Double wall, lockable lid (lock not included)
- Nestable
- Water resistant
- Four convenient sizes



S.O.S Bins	Outside Dimensions (In.)			Load Rating			
	Model No.	L	W	H	Cu. Ft.	Cu. M.	Load Rating
	S055.5	30	24	23	5.5	0.17	500
	S0511	42	29	30	11	0.33	1000
	S0518	48	33	34	18.5	0.56	1750
	S0536	72	36	36	36	1.08	3500

Scoop

Large Scoop with built-in Handle. Perfect for spreading contents of S.O.S bins. Leave inside bin to have on hand at all times.



TSSCOOP

Nesting Fork Lift Bins

- 4 way entry
- Stackable with covers
- Barrel type nesting stops prevent jamming
- Rotator bars optional
- Cover included

Nesting Fork Lift Bins	Outside Dimensions (In.)			Load Rating			
	Model No.	L	W	H	Cu. Ft.	Cu. M.	Load Rating
	TS4800	48	42	30	24	0.72	1200
	TS4900	44	44	46	38	1.14	2000



Bullseye Hole-In-One

- Co-mingle hole design can accommodate all your recycling/waste disposal needs
- Lids and base available in different colors to manage your stations more efficiently
- Joiners available

Hole-In-One	Dimensions (In.)			Capacity		
	Model No.	L	W	H	Imp Gal	L
	TS550	17	17	31	22	114

Polybag size for liner 30" x 38" (762 x 965 mm)



Waste & Recycling

BULK HANDLING & WASTE TRANSPORT SYSTEMS

Bullseye Round Hole

- The 549 A is designed for the source separation of recyclable cans, bottles, drink boxes and polystyrene
- The container comes complete with a round hole in the lid and appropriate bilingual, recycling decals

Round Hole 16 Gal.	Dimensions (In.)			Capacity		
Model No.	L	W	H	Imp Gal	L	Lid
TS549A	20 ½	11	34	16	72.7	Included



Bullseye Rectangular Slot

- The 549 B is designed for the source separation of recyclable fine paper and newspaper
- The container comes complete with a rectangular slot in the lid and appropriate bilingual, recycling decals

Rectangular 16 Gal.	Dimensions (In.)			Capacity		
Model No.	L	W	H	Imp Gal	L	Lid
TS549B	20 ½	11	34	16	72.7	Included

Bullseye 30 Gal.

- The 559 is a mid-sized Bullseye™ designed for recycling various materials in offices, cafeterias and other high volume areas
- Two lid configurations are available: 559 A - Round hole for cans, 559 B - Square opening for paper

30 Gal.	Dimensions (In.)			Capacity		
Model No.	L	W	H	Imp Gal	L	Lid Design
TS559A	20 ½	20 ½	34	30	136.4	Round Hole
TS559B	20 ½	20 ½	34	30	136.4	Square Opening



Bullseye Half Moon

- For recycling cans, bottles, paper, etc.
- Half Moon Bullseye™ are also available with 2 containers mounted back to back and attached permanently to a dolly with or without lid

Half Moon	Dimensions (In.)			Capacity		
Model No.	L	W	H	Imp Gal	L	Lid Design
TS519A	22 ½	12 ¼	36	15	68.2	Round Hole
TS519B	22 ½	12 ¼	36	15	68.2	Rectangular Slot

Bullseye Jumbo

- The 108 JB is our largest Bullseye™ designed for recycling cans on a large quantity basis
- The container comes complete with a round hole and wasp flap in the lid and appropriate bilingual, recycling decals

Jumbo	Dimensions (In.)			Capacity		
Model No.	L	W	H	Imp Gal	L	Lid Design
TS108JB	24 ½	24 ½	34	45	204.6	Round Hole





Waste & Recycling

BULK HANDLING & WASTE TRANSPORT SYSTEMS

Bullseye Trio

- Waste and Recycling combined in one convenient station
- High end quality at a reasonable price
- Heavy duty roto moulded in esthetically pleasing sandstone and premium colors
- Three removable plastic liners included
- Three sets of Recycling labels included to customize your TRIO
- Meets and or exceeds 25% Recycled materials standard
- All hardware and hinges made of stainless steel
- Lockable



Trio	Dimensions (In.)					Lid Design
Model No.	L	W	H	Imp Gal	L	Lid Design
TSS75	54	19 1/2	38	18	82	Hinged

Liners (3 incl.) 22 US gallons (82L), 17" x 17" x 27" (432 x 432 x 686 mm) Polybag size for liner 30" x 38" (762 x 965 mm) *Each section

Bullseye Duo

- Heavy Duty roto moulded plastic
- Comingle and rectangular openings
- Openings: round 5.5", comingle 8" x 5.5", rectangular 8" x 5.5"
- Meets and or exceeds 25% Recycled materials standard
- 2 liners included (17" x 17" x 27")
- Labels included



Duo	Dimensions (In.)					Lid Design
Model No.	L	W	H	Imp Gal	L	Lid Design
TSS65	36	19 1/2	38	18	82	Hinged

Polybag size for liner 30" x 38" (762 x 965 mm) *Each section

Bullseye Twin & Triplet

- Recycling and waste disposal in one unit
- Smooth ergonomic design for easy cleaning
- A range of attractive colours to choose from
- The option of having a black base to increase recycled content
- Stress-free rotomoulding for extra strength and durability
- A variety of labels are included (3 languages) with every unit
- Hinged lid
- Twin comes with two liners and Triplet with three. (12 imperial gallon liners - use 26" x 36" garbage bags)
- Either hole can be trimmed out larger



Twin	Dimensions (In.)			Each Liner		Lid Design
Model No.	L	W	H	Imp Gal	L	Lid Design
TSS85	33	17	28	12	55	Hinged

Triplet	Dimensions (In.)			Each Liner		Lid Design
Model No.	L	W	H	Imp Gal	L	Lid Design
TSS95	47	17	28	12	55	Hinged



Waste & Recycling

BULK HANDLING & WASTE TRANSPORT SYSTEMS

MegaKart

- 65 and 96-Gallon carts designed for residential waste management
- Compatible with automated and semi-automated systems
- Attached lid swings out of the way for easy dumping
- Injection molded for exceptional durability and cost effectiveness
- Resists damage from oil and most chemicals
- Engineered for rigidity and strength
- Colors: Dark Green, Dark Blue, and Light Gray



Patented design allows carts to nest with installed lids and latchbars for compact shipping and storage.



Foot Tilt Pocket molded above axle for maximum leverage and utility.



MegaKart	Dimensions (In.)				Capacity	Load
Model No.	W	D	H	Wheel Dia.	Imp Gal	Lbs.
79532	19	23 ¼	37 ½	8	35	
79564	24	27 ½	43 ¼	10	65	224
79596	23	31 ½	46	10	96	336

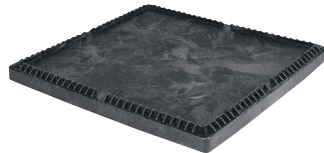

Recycling Containers

- Variety of sizes simplifies separation of glass, paper, and plastic for sorting or pickup
- Durable plastic construction with a UV inhibitor to resist fading
- Withstands a wide temperature range -20° F to 120° F
- Containers are imprinted to increase program awareness
- Color: Blue

Recycling Containers	Dimensions (In.)			Capacity	Load
Model No.	L	W	H	Cu. Ft.	Lbs.
TS7701	11 ¼	8	12 ¼	-	-
TS7702	14 ½	10 ½	15 ½	-	-
075-611	20 ¾	15	12	1.69	48
RC25141401	25	17	13	2.54	72
BN48453420	48	45	34	-	1800
TS48450300	48 ¾	45 ¼	2 ¾	-	-
TS48450300					

EZ-Sorters

- Hooks to a DESKSIDERTM and it instantly becomes a complete source separation system
- Waste goes in the EZ-SORTERTM, your recyclable papers go in the TECHSTAR DESKSIDERTM
- Available in convenient 4L and 2L capacity

EZ-Sorters	Dimensions (In.)			Capacity
Model No.	L	W	H	Imp. Gal.
TSEZ-200	7	5	6	.44
TSEZ-400	8	6	9	.88



Bulk Containers - Collapsible



BG Model General Purpose Containers

- Rated for load capacities up to 1,200 lbs.
- Locking latches secure panels and doors
- 9 feet or 5 plastic runners
- Plastic runners for added stacking strength
- Backed by a one-year limited warranty
- 100% recyclable HDPE

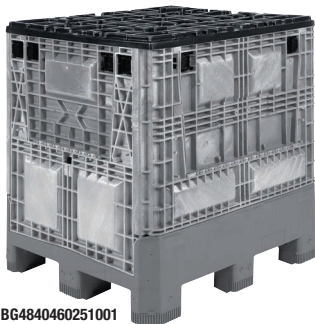

BG4840460251001

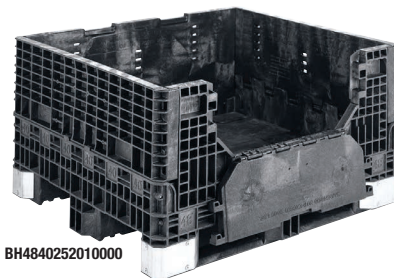

BH4840252010000

BH Model Heavy-Duty Containers

- Rated for load capacities up to 2,500 lbs.
- Reinforced base with 3 steel runners for durability
- Post-and-pocket side panels interlock for strength
- Steel corner hit plates deflect fork tines
- Backed by a one-year limited warranty
- 100% recyclable HDPE

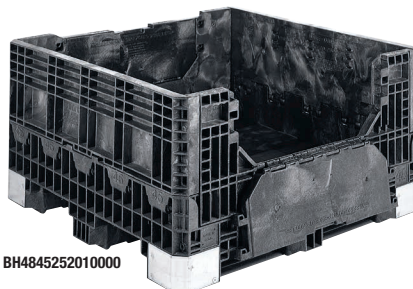

BH4845252010000



BI4840392010000

BI Model Industry Standard Containers

- Rated for load capacities up to 1,600 lbs.
- Locking latches for sidewalls and drop doors
- Backed by a one-year limited warranty
- 100% recyclable HDPE

BN Extra-Duty Boxes

- Rated for load capacities up to 2,500 lbs.
- Backed by a one-year limited warranty
- 100% recyclable HDPE



BN4845342010000



BN4845342023000

BS Model Containers

- Post-and-pocket interlocking side panel design
- Steel corner hit plates deflect fork tines
- Steel runners and hit plates for extra durability
- Backed by a one-year limited warranty
- 100% recyclable HDPE

BX Model Industry Standard Containers

- Snap-lock latches for sidewalls and drop doors
- Plastic runners for added stacking strength
- Backed by a one-year limited warranty
- 100% recyclable HDPE



BS3230342010000



BX484544B010000

GH, GL, GP Maximizer® Container System

- One person can quickly and easily assemble and collapse; folds flat and fits within its own footprint
- Ship and store light-duty dry goods, lightweight components and more!
- Two full-width doors improve access and ergonomics
- One assembled unit can store eight collapsed boxes inside
- Backed by a one-year limited warranty
- 100% recyclable to meet sustainability initiatives



GH4840412010100

Maximizer



GL4840412010100

Maximizer



GP4840412010100

Maximizer

Bulk Containers - Collapsible				External Dimensions (In.)			Internal Dimensions (In.)			Capacity			Fork Tunnel Dimensions				Truck Capacity				
Model No.	Description	Color	Doors	L	W	H	L	W	H	Weight lbs.	Lbs.	Vol. Cu. Ft.	Vol. Gal.	Long Side L	Long Side H	Short Side L	Short Side H	Return Ratio	53' Truck Opened	53' Truck Collapsed	
32" x 30" Footprint																					
BN3230252010000	Industry Standard 32" x 30" x 25 Bulk Box	Black	2 Doors on Length	32	30	25	29.5	27.5	18.4	63	1800	8.6	64.3	10.6	3.5	7.6	2	1.9:1	240	480	
BN3230342010000	Industry Standard 32" x 30" x 34 Bulk Box	Black	2 Doors on Length	32	30	34	29.5	27.5	27.4	76	1800	12.9	96.5	10.6	3.5	7.6	2	2.6:1	180	480	
48" x 40" Footprint																					
BH4840252010000	Heavy-Duty 48" x 40" x 25 Bulk Box	Black	2 Doors on Length	47.62	39.75	25.50	44	36.25	18.25	121	2500	16.85	126	11.75	3.16	10.38	4.13	2.1:1	120	240	
BG4840332063002	General Purpose 48" x 40" x 33" 5-Rail Base Bulk Box	Blue	2 Doors on Length	48	40	34.5	45	37	27	129	1200	28.3	212	13	4	12	4	2.7:1	90	210	
BH4840342010000	Heavy-Duty 48" x 40" x 34 Bulk Box	Black	2 Doors on Length	47.62	39.75	33.87	44	36.25	26.50	141.2	2500	24.46	183	11.75	3.16	10.38	4.13	3:1	90	242	
BI4840342010000	Industry Standard 48" x 40" x 34 Bulk Box	Black	2 Doors on Length	47.5	39.5	34.1	44.3	36.2	26.6	126	1600	24.7	185	13.1	4.0	11.1	4	2.3:1	90	210	
BI4840392010000	Industry Standard 48" x 40" x 39 Bulk Box	Black	2 Doors on Length	47.5	39.5	39.5	44.3	36.2	32.1	137	1600	29.8	223	13.1	4.0	11.1	4	2.6:1	60	210	
BG4840460251001	General Purpose 48" x 40" x 46" 9 Feet Base Bulk Box	Lt. Gray	2 Doors on Width	48	40	46	45	37	40	142	1200	38.5	288	13	3.5	12	3.5	3.6:1	60	240	
48" x 45" Footprint																					
BN4845252010000	Extra-Duty 48" x 45" x 25 Bulk Box	Black	2 Doors on Length	48	45	25	44.5	41.5	18.3	100	2500	19.1	143	31.8	10.3	12.3	3.3	2.3:1	104	208	
BH4845252010000	Heavy-Duty 48" x 45" x 25 Bulk Box	Black	2 Doors on Length	47.62	44.62	25.62	44.25	41.25	18.69	140	2500	19.74	148	11.88	3.25	10.5	3.69	2.1:1	112	224	
BH4845342010000	Heavy-Duty 48" x 45" x 34 Bulk Box	Black	2 Doors on Length	47.62	44.62	34	44.25	41.25	27.12	163	2500	28.65	214	11.88	3.25	10.5	3.69	3:1	84	224	
BN4845342010000	Extra-Duty 48" x 45" x 34 Bulk Box	Black	2 Doors on Length	48	45	34	44.5	41.5	27	122	2500	28.7	215	11	3.3	12.3	3.3	3:1	78	234	
BN4845342023000	Extra-Duty 48" x 45" x 34 Bulk Box	Blue	2 Doors on Length	48	45	34	44.5	41.5	27	122	2500	28.7	215	11	3.3	12.3	3.3	3:1	78	234	
BN4845352010000	"Extra-Duty 48" x 45" x 35 Bulk Box"	Black	2 Doors on Length	48	45	35	44.5	41.5	28	132	2000	29.9		11	3.3	12.3	3.3	1.7:1	78	130	
BN4845392010000	"Extra-Duty 48" x 45" x 39 Bulk Box"	Black	2 Doors on Length	48	45	39	44.5	41.5	32	149	2000	29.9		11	3.3	12.3	3.3	2.1:1	52	130	
BN4845412010000	"Extra-Duty 48" x 45" x 41 Bulk Box"	Black	2 Doors on Length	48	45	41	44.5	41.5	34	147	2000	29.9		11	3.3	12.3	3.3	2.1:1	52	130	
BN4845442010000	"Extra-Duty 48" x 45" x 44 Bulk Box"	Black	2 Doors on Length	48	45	44	44.5	41.5	37	154	2000	29.9		11	3.3	12.3	3.3	2.1:1	52	104	
BN4845512010000	"Extra-Duty 48" x 45" x 51 Bulk Box"	Black	2 Doors on Length	48	45	51	44.5	41.5		179	2000	29.9		11	3.3	12.3	3.3	1.7:1	52	78	

*Many other sizes available upto 70" long x 50" Tall

Bulk Containers - Maximizer				External Dimensions (In.)			Internal Dimensions (In.)			Capacity			Fork Tunnel Dimensions				Truck Capacity			
Model No.	Description	Color	Doors	L	W	H	L	W	H	Weight lbs.	Lbs.	Vol. Cu. Ft.	Vol. Gal.	Long Side L	Long Side H	Short Side L	Short Side H	Return Ratio	53' Truck Opened	53' Truck Collapsed
GH4840412010100	Maximizer 48" x 40" x 41" Pallet, Sleeve, Pallet for Lid	Black	2 Doors on Length	48	40	46.5	45.4	37.2	36	101	1000	35	262	9.7	3.5	9.9	3.5	4:1	60	240
GL4840412010100	Maximizer 48" x 40" x 41" Pallet, Sleeve, Lid	Black	2 Doors on Length	48	40	42.6	45.4	37.2	36	90	800	35	262	9.7	3.5	9.9	3.5	5:1	60	300
GP4840412010100	Maximizer 48" x 40" x 41" Pallet, Sleeve, No Lid	Black	2 Doors on Length	48	40	41.3	45.4	37.2	36	75	800	35	262	9.7	3.5	9.9	3.5	-	30	360

Capacity is dependent upon application and use environment. It is based on equally distributed loads. Elevated temperatures or concentrated loads may affect capacity. Check with your A-K West representative for suitability in your application. Specifications subject to change without notice. All dimensions are approximate.

Bulk Containers - Specialty



BF Model Containers

- Solid, one-piece base for maximum strength and durability
- Automation friendly
- Withstands exposure to sunlight and cooling processes
- Resists impact and moisture
- Designed with rounded rims and corners – easy to keep clean
- Will not rust, peel or splinter, rot or absorb odors
- Backed by a one-year limited warranty
- 100% recyclable HDPE

CF Model CenterFlow™ Container

- The standard in the industry for safe handling of seed products
- Smooth, funnel-shaped interior with a 35° angle
- Protects contents from dirt, moisture and pests
- Resists impact and most chemicals
- Will not rust, peel or splinter
- Zipper cardholders hold identification tags and forms
- Reinforced feet with steel hit plates
- The side door allows one person to control the flow and safely remove all or part of the contents
- Backed by a one-year limited warranty
- 100% recyclable HDPE

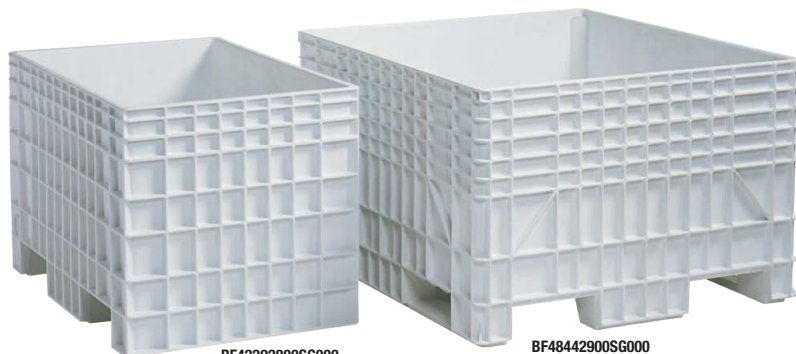

BF42292800SG000
(solid sides)

BF48442900SG000
(solid sides)



BF484515XP23000



BZ48404600



BZ484447V0

CenterFlow™
BY BUCKHORN



TS4900
See pg 100 for specs



CF57456500



Bulk Containers				External Dimensions (In.)			Internal Dimensions (In.)			Capacity			Fork Tunnel Dimensions				Truck Capacity			
Model No.	Description	Color	Doors	L	W	H	L	W	H	Weight lbs.	Lbs.	Vol. Cu. Ft.	Vol. Gal.	Long Side L	Long Side H	Short Side L	Short Side H	Return Ratio	53' Truck Opened	53' Truck Collapsed
BF4229280010000	Stack Only Agricultural Container	Black	0 Doors	41.8	28.8	27.8	38.5	25.5	22.3	74	900	13.8	103.3	10.5	3.9	—	—	1:1	132	—
BF422928005G000	Stack Only Agricultural Container	White	0 Doors	41.8	28.8	27.8	38.5	25.5	22.3	74	900	13.8	103.3	10.5	3.9	—	—	1:1	132	—
BF4844290010000	Stack Only Agricultural Container	Black	0 Doors	47.9	43.8	29.4	45.4	41.4	23.4	95	700	25.9	185.2	11.7	3.1	11.7	4.3	1:1	84	—
BF484429005G000	Stack Only Agricultural Container	White	0 Doors	47.9	43.8	29.4	45.4	41.4	23.4	95	700	25.9	185.2	11.7	3.1	11.7	4.3	1:1	84	—
BF484515XP23000	Extra-Duty Transport Tub 48" x 45" x 15"	Blue	0 Doors	48	45	15	44.5	41.6	8.2	90	2300	8.8	66	11.6	3.3	11.9	3.4	1:1	182	—
BF484519XP23000	Extra-Duty Transport Tub 48" x 45" x 19"	Blue	0 Doors	48	45	19	44.5	41.6	12.2	118	2300	13.1	98	11.6	3.3	11.9	3.4	1:1	130	—
BZ4840460005000	All Plastic, No Drop-Door, Top Discharge	Tan	0 Doors	48	40	46	45	37	40.3	128.5	2000	40.5	-	13.10	3.4	11.1	3.4	3.3:1	60	240
BZ48404610	All Plastic, Drop-Door, Top Discharge	Tan	1 Door	48	40	46	45	37	40.3	128.5	2000	40.5	-	13.10	3.4	11.1	3.4	3.3:1	60	240
BZ484046T051000	Steel Reinforced, No Drop-Door, Top Discharge	Grey	0 Doors	48	40	46	45	37	40.3	168.5	2500	40.5	-	13.10	3.4	11.1	3.4	3.3:1	60	240
BZ4840460V	Steel Reinforced, No Drop-Door, Bottom Discharge	Grey	0 Doors	48	40	46	45	37	40.3	168.5	2500	40.5	-	13.10	3.4	11.1	3.4	3.3:1	60	240
BZ4840461T	Steel Reinforced, Drop-Door, Top Discharge	Grey	1 Door	48	40	46	45	37	40.3	168.5	2500	40.5	-	13.10	3.4	11.1	3.4	3.3:1	60	240
BZ4840461V	Steel Reinforced, Drop-Door, Bottom Discharge	Grey	1 Door	48	40	46	45	37	40.3	168.5	2500	40.5	-	13.10	3.4	11.1	3.4	3.3:1	60	240
BZ48444700	Caliber 315 top discharge w/lid	Grey	0 Doors	48	44	47	44.9	40.9	40.9	225	3370	-	315	-	-	-	-	2.5:1	56	168
BZ484447V0U1000	Caliber 315 bottom discharge w/lid	Grey	0 Doors	48	44	47	44.9	40.9	40.9	225	3370	-	315	-	-	-	-	2.5:1	56	168

CenterFlow Bulk Container				Outside Top Dimensions (In.)			Inside Top Dim. (In.)		Capacity			Fork Tunnel Dimensions				Truck Capacity		
Model No.	Description	Doors	L	W	H	L	H	Weight lbs.	Lbs.	Vol. Cu. Ft.	Bushel	Long Side L	Long Side H	Short Side L	Short Side H	Return Ratio	53' Truck Opened	53' Truck Collapsed
CF574500650010143	CenterFlow 57" x 45" Base, Ring, Lid	Side Access Sliding Door; Bottom Exit Port	56.5	45	65	53.5	42	331	2500	58.3	46.9	7.75	3.78	9.84	3.63	1.6:1	22	44

Bulk Container Lids & Pallet Top Caps			Outside Dimensions (In.)				Weight lbs.	Container Compatibility
Model No.	Description	Color	L	W	H			
TH4840020010000	Structural Foam Lid	Black	48.38	40.44	2.12	18.6	Fits BH4840 Series	
TH4845020010000	Structural Foam Lid	Black	48.25	45.25	2.25	20.7	Fits BH4845 Series	
TL4229040010000	Structural Foam Lid	Black	42.5	29.7	3.2	15.3	Fits BF4229	
TL422904005G000	Structural Foam Lid	White	42.5	29.7	3.2	15.3	Fits BF4229	
TL4840030010000	Structural Foam Lid	Black	47.8	40.0	2.8	19.1	Fits BI4840 Series	
TL4844030010000	Structural Foam Lid	Black	48.9	44.8	2.8	20.9	Fits BF4844	
TL484403005G000	Structural Foam Lid	White	48.9	44.8	2.8	20.9	Fits BF4844	
TN4845020010000	Injection Molded Top Cap	Black	48.8	45.8	2.1	20	Use with PN Pallet, Straight Wall Containers	
TS4840020010000	Structural Foam Lid	Black	49.1	41.1	2.5	21.8	Fits BG4840 Series with Runners	
TS3230020010000	Structural Foam Lid	Black	32.75	30.75	2.3	10.3	Fits BF3230 and BS3230 Series	
TS4845030010000	Structural Foam Lid	Black	49.8	46.8	3.8	25	Fits BE4845, BN4845 and BX4845 Series	
TV5748020010000	Vacuum Formed Lid	Black	58	48.2	2.1	18	Fits BF5748 and BS5748 (not stocked)	
TV6448020010000	Vacuum Formed Lid	Black	65	48.2	2.1	21	Fits BF6448 and BS6448 (not stocked)	
TV7048020010000	Vacuum Formed Lid	Black	71	48.2	2.1	22	Fits BF7048 and BS7048 (not stocked)	

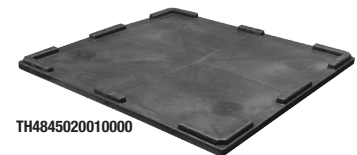

TH4845020010000



TN4845020010000

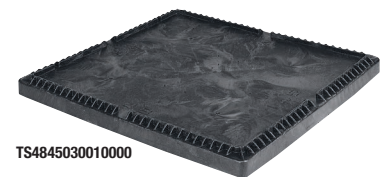

TS4845030010000

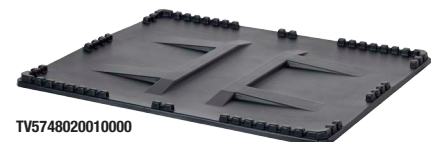

TV5748020010000

Capacity is dependent upon application and use environment. It is based on equally distributed loads. Elevated temperatures or concentrated loads may affect capacity. Check with your A-K West representative for suitability in your application. Specifications subject to change without notice. All dimensions are approximate.

Pallets



- Buckhorn Pallets maintain their strength over repeated uses
- Hundreds of round trips for lower overall cost-per-trip



PM4848060010004 **NR**

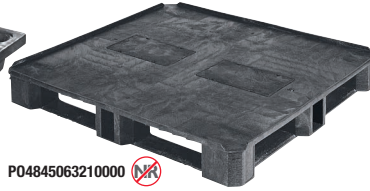

P04845063210000 **NR**

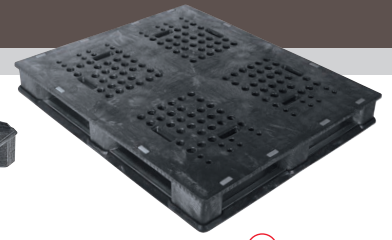

PU4840063310006 **ER**



PL4840060026000 **NR**



PN4845063310000 **NR**



ECOUS0D6RM **SR**



PW484062210000 **SR**

ER = Edge Rackable
SR = Standard Rack
NR = Not Rackable
unless fully supported

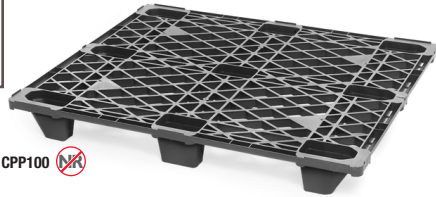

CPP100 **NR**



CPP200 **NR**

Pallets			External Dimensions (In.)			Weight Capacity			Fork Tunnel Dimensions					Truck Capacity	
Model No.	Description	Color	L	W	H	Weight lbs.	Static Lbs.	Dynamic Lbs.	Rack Lbs.	Long Side L	Long Side H	Short Side L	Short Side H	Return Ratio	53' Truck
CPP100ACM	48 x 40 Nestable Export Pallet, Open Deck	Black	48	40	5.2	12	3500	2200	N/R	10	4	12	4	3:1	1950
CPP100CPE	48 x 40 Nestable Pallet, Closed Deck	Black	48	40	5.2	15	3500	2200	N/R	10	4	12	4	3:1	1950
CPP100PE	48 x 40 Nestable Pallet, Open Deck	Black	48	40	5.2	11	3500	2200	N/R	10	4	12	4	3:1	1950
CPP103PE	48 x 40 Pallet, 3 Runners, Open Deck	Black	48	40	5.6	15.5	3500	2800	N/R	10	3.6	12	4.4	1:1	1950
CPP200ACM	31.5 x 26.6 x 5.1 Nestable Display Pallet	Black	31.5	26.6	5.1	7.7	5500	2200	N/R	9.8	3.74	9	3.74	3:1	2640
CPP330ACM	48.0 x 40.0 x 5.5	Black	48	40	5.5	22	8800	3100	N/R	13.8	3.9	10.6	3.9	3:1	1590
ECOUS5CD3R	3 Runner Closed Deck	Black	48	40	6.11	37	8800	4400	2200	12.25	3.75	11.25	4	1:1	-
ECOUS5OD3R	3 Runner Open Deck	Black	48	40	6.11	31	8800	4400	2200	12.25	3.75	11.25	4	1:1	-
ECOUS5OD6R	6 Runner Open Deck	Black	48	40	6.10	34	8800	4400	2200	12.25	3.75	11.25	3.75	1:1	-
ECOUS5CD6R	6 Runner Closed Deck	Black	48	40	6.11	40	8800	4400	2200	12.25	3.75	11.25	3.75	1:1	-
ECOUS5OD6RM	"6 Runner Open Deck Metal Reinforced"	Black	48	40	6.11	48	11200	5600	2800	12.25	3.75	11.25	3.75	1:1	-
ECOUS5CD6RM	"6 Runner Closed Deck Metal Reinforced"	Black	48	40	6.11	54	11200	5600	2800	12.25	3.75	11.25	3.75	1:1	-
PD4840060010000	48" x 40" x 6" Nestable Pallet	Dk. Gray	48	40	6.3	26	30,000	3000	N/R	11.7	3.9	11.2	3.9	2.6:1	1,230
PL4840060026000	Light-Duty 48" x 40", Nestable Pallet	Husky Gray	48	40	6	19	10,000	1200	N/R	12	4	12	4	2:1	1,200
PL4840073226000	Light-Duty 48" x 40", 5-Rail, 2-way Runners Pallet	Husky Gray	48	40	6.5	29	10,000	2500	N/R	12	3.5	12	3.5	1:1	480
PM3230063210000	Medium-Duty 32" x 30", 1/2" Lip Pallet	Black	32	30	6.5	25.7	20,000	3000	N/R	9	3.7	8.7	3.7	1:1	1,023
PM4848060010004	Medium-Duty 48" x 48", Nestable Pallet	Black	48	48	6	40	30,000	4000	N/R	9.9	4.3	15.9	4.3	3:1	1,066
PN4845063310000	Medium-Duty 48" x 45", 1" Lip Pallet	Black	48.8	45.8	5.5	53	30,000	4000	N/R	11	3.5	11.5	3.5	1:1	494
P04845063210000	48" x 45", 3/4" Lip, 5-Rail Pallet	Black	48.75	45.75	6.6	58	30,000	3000	N/R	13.12	3.65	13.45	3.65	1:1	468
PU4840063310006	Universal Pallet 48" x 40" Pallet	Black	48	40	5.56	68.3	30,000	5000	2800	13.1	3.53	12	3.53	1:1	540
PW484062210000	Medium-Duty 48" x 40", 1/2" Lip Pallet	Black	47.62	39.75	6.9	42.4	20,000	7000	2400*	11.75	3.38	10.38	3.38	1:1	480
PW4845062210000	Medium-Duty 48" x 45", 1/2" Lip Pallet	Black	47.62	44.75	6.9	50.5	20,000	7000	2400*	11.88	3.38	10.38	3.38	1:1	442

*Optional center steel runner required

Straight Wall Containers



- Stack-only modular containers
- Ideal for closed loop shipping, in-process handling and storage applications
- Containers cube 48" x 45" pallets
- Interworking sizes allow mixed stacking on pallet
- Manufactured from FDA-approved materials
- Model Numbers with F1 have been reworked with the following design changes:
 - Larger, more ergonomically friendly handle
 - Fingertip handles on other two sides
 - Lower tare weight
 - Perimeter dust skirts
 - Designed to work with the PN4845 pallet (page 6) and the TN4845 top cap (page 5)

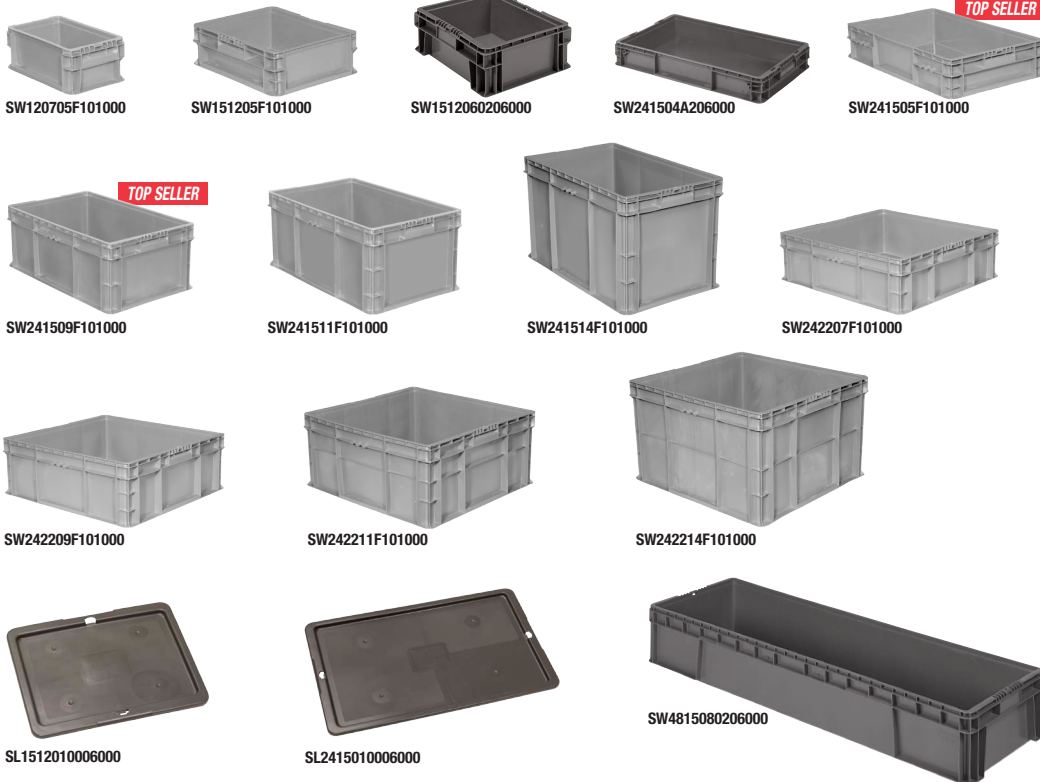

Straight Wall Containers			Outside Dimensions (In.)			Bottom Dimensions (In.)			Truck Capacity			Accessories	
Model No.	Description	Color	L	W	H	L	W	H*	Weight lbs.	Weight Capacity lbs.	Volume Cu. Ft.	53' Truck	Lid
SW120705F101000	Solid Bottom/Sides 12" x 7" x 5"	FDA Lt. Gray	12	7	5	9.5	5.6	4.4	1.2	60	0.1	11,232	—
SW151205F101000	Solid Bottom/Sides 15" x 12" x 5"	FDA Lt. Gray	15	12	5	13.1	9.5	4.4	1.8	100	0.3	5,616	SL1512010006000
SW1512060206000	Solid Bottom/Sides 15" x 12" x 5.5"	FDA Dk. Gray	15	12	5.5	13	9.4	4.8	2.3	100	0.31	5,304	SL1512010006000
SW151207F101000	Solid Bottom/Sides 15" x 12" x 7.5"	FDA Lt. Gray	15	12	7.5	13.1	9.5	6.9	2.3	100	0.5	3,744	SL1512010006000
SW151209F101000	Solid Bottom/Sides 15" x 12" x 9.5"	FDA Lt. Gray	15	12	9.5	13.1	9.5	8.9	2.7	100	0.6	2,808	SL1512010006000
SW2411100206000	Solid Bottom/Sides 24" x 11" x 9.5"	FDA Dk. Gray	24	11	9.5	21.38	9.13	8.88	4.5	100	1	2,160	—
SW241504A206000	Solid Bottom/Sides 24" x 15" x 4"	FDA Dk. Gray	24	15	4	21.38	13	3.38	2.9	100	0.5	3,744	SL2415010006000
SW241505F101000	Solid Bottom/Sides 24" x 15" x 5"	FDA Lt. Gray	24	15	5	21.5	13.1	4.4	3	100	0.7	2,808	SL2415010006000
SW2415060206000	Solid Bottom/Sides 24" x 15" x 5.5"	FDA Dk. Gray	24	15	5.5	21.4	13	4.8	3.7	100	0.8	2,652	SL2415010006000
SW241507F101000	Solid Bottom/Sides 24" x 15" x 7.5"	FDA Lt. Gray	24	15	7.5	21.5	13.1	6.9	3.7	100	1.1	1,872	SL2415010006000
SW241509F101000	Solid Bottom/Sides 24" x 15" x 9.5"	FDA Lt. Gray	24	15	9.5	21.5	13.1	8.9	4.3	100	1.5	1,404	SL2415010006000
SW241511F101000	Solid Bottom/Sides 24" x 15" x 11"	FDA Lt. Gray	24	15	11	21.5	13.1	10.4	4.6	100	1.7	1,248	SL2415010006000
SW241514F101000	Solid Bottom/Sides 24" x 15" x 14.5"	FDA Lt. Gray	24	15	14.5	21.5	13.1	13.9	5.5	100	2.3	936	SL2415010006000
SW242207F101000	Solid Bottom/Sides 24" x 22.5" x 7.5"	FDA Lt. Gray	24	22.5	7.5	21.5	20.6	6.9	4.9	100	1.8	1,352	**
SW242209F101000	Solid Bottom/Sides 24" x 22.5" x 8.7"	FDA Lt. Gray	24	22.5	8.7	21.5	20.6	8.1	5.3	100	2.1	1,144	**
SW242211F101000	Solid Bottom/Sides 24" x 22.5" x 11"	FDA Lt. Gray	24	22.5	11	21.5	20.6	10.4	6	100	2.7	936	**
SW242214F101000	Solid Bottom/Sides 24" x 22.5" x 14.5"	FDA Lt. Gray	24	22.5	14.5	21.5	20.6	13.9	7.2	100	3.6	624	**
SW3215080206000	Solid Bottom/Sides 32" x 15" x 7.5"	FDA Dk. Gray	32	15	7.5	29.38	13	6.88	5.6	100	1.52	1,248	**
SW3215080209000	Solid Bottom/Sides 32" x 15" x 7.5"	FDA Dk. Blue	32	15	7.5	29.38	13	6.88	5.6	100	1.52	1,248	**
SW4815080206000	Solid Bottom/Sides 48" x 15" x 7.5"	FDA Dk. Gray	48	15	7.5	45.38	13	6.88	7.5	100	2.4	936	**
SW4815080209000	Solid Bottom/Sides 48" x 15" x 7.5"	FDA Dk. Blue	48	15	7.5	45.38	13	6.88	7.5	100	2.4	936	**

*Useable height. **Lid available, non-stock item; minimum quantities apply.

Capacity is dependent upon application and use environment. It is based on equally distributed loads. Elevated temperatures or concentrated loads may affect capacity. Check with your A-K West representative for suitability in your application. Specifications subject to change without notice. All dimensions are approximate.

Attached Lid Containers



- Ideal for shipping, picking and storage
- Containers nest when not in use, saving space in trucks and storerooms
- Light Gray Containers manufactured from FDA-approved materials



Attached Lid Containers			Outside Dimensions (In.)			Bottom Dimensions (In.)			Truck Capacity						
Model No.	Description	Color	L	W	H	L	W	H	Weight lbs.	Weight Capacity lbs.	Volume Cu. Ft.	Nesting Ratio	Lid Type	53' Truck Stacked	53' Truck Nested
AR2012070201000	ALC Solid/Textured Bottom	Gray	20	11.69	7.5	16.88	9.63	6.06	3.78	40	0.6	3:1	(R)	3,720	6,480
AC2115090201000	ALC Solid/Textured Bottom	Gray	21.75	15.25	9.63	18.38	13	8.13	5.1	60	1.22	4.3:1	(R)	1,991	4,872
AC2115090204000	ALC Solid/Textured Bottom	Green	21.75	15.25	9.63	18.38	13	8.13	5.1	60	1.22	4.3:1	(R)	1,991	4,872
AC21151202	ALC Solid/Textured Bottom	Gray, Red, Blue, Green, Black	21.75	15.25	12.5	17.88	12.5	11.13	5.6	60	1.4	5:1	(R)	1,448	4,176
AS2213120201000	ALC Solid/Textured Bottom; Open Handholds	Gray	22.38	12.8	12.88	18.8	10.1	11.8	6.08	60	1.3	4:1	(S)	1,568	4,702
AR15141302	Attached Lid Container	Gray	15	14	13	-	-	-	-	-	-	-	-	-	-
AR15141502	Attached Lid Container	Gray	15	14	15	-	-	-	-	-	-	-	-	-	-
AR24201202	ALC Solid/Smooth Bottom	Gray, Blue	24	19.5	12.63	20.5	16.6	10.8	8.1	80	2.3	5.6:1	(R)	1,000	3,840
AR27170902	Attached Lid Container	Green	27	17	9	-	-	-	-	-	-	-	-	-	-
AR27171202	ALC Solid/Textured Bottom	Gray, Red, Green, Blue	27	16.88	12.5	23.5	13.8	10.9	8.2	100	2.25	4.3:1	(R)	1,072	3,162
AS2821150201000	ALC Solid/Textured Bottom	FDA Lt. Gray	28	20.75	15.44	25	18	14	13.1	100	3.6	2.8:1	(S)	624	1,496
AS3424201201000	ALC Solid/Smooth Bottom; Open Handholds	FDA Lt. Gray	34	24	19.63	29.9	19.5	18.1	19	100	6.1	2.7:1	(S)	390	816

(R) Recessed Lid (S) Strapping Lid

Detached Lid Containers

- Containers stack firmly with lids, nest when empty, and interwork for optimum space utilization
- Detached lids snap tight for secure closure
- Manufactured from FDA-approved materials



Detached Lid Containers			Outside Dimensions (In.)			Bottom Dimensions (In.)			Truck Capacity (with Lids)						
Model No.	Description	Color	L	W	H	L	W	H	Weight Lbs.	Weight Capacity Lbs.	Vol w Lid Cu. Ft.	Nesting Ratio	53' Truck Stacked	53' Truck Nested	
DL2115090201000	Ergonomic Handles/Solid Bottom	FDA Lt. Gray	21.38	15.25	9.56	18.4	13	9.0	3.4	60	1.22	4.3:1	2,046	5,712	
DL2420120201000	Ergonomic Handles/Solid Bottom	FDA Lt. Gray	24	20	12.38	20.5	16.6	11	5.5	100	2.36	5.5:1	992	4,120	
DR2115010001000	Recessed Lid	FDA Lt. Gray	21.38	15.13	1.13	-	-	-	1.6	-	-	-	-	-	
DR2420010001000	Recessed Lid	FDA Lt. Gray	24	20	1.13	-	-	-	2.0	-	-	-	-	-	
C18-541E05	CFIA Approved	Beige	24	16	8.75	-	-	-	-	-	-	-	-	-	
C18-525E05	CFIA Approved Lid for C18-451E5	Beige	24	16	1	-	-	-	-	-	-	-	-	-	

Attached Lid Containers



Attached Lid Containers

INDUSTRIAL-GRADE

FEATURES

- 1 Textured bottoms provide a sure grip on conveyor belts
- 2 Strong molded-in handle grips are ergonomically designed for easy lifting and carrying
- 3 Padlock eye on both ends accommodate security ties
- 4 Reinforced hinge pins for years of smooth lid operation

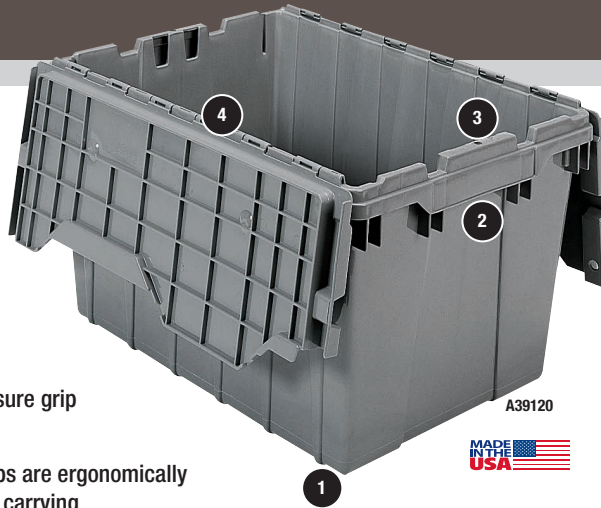

COLORS

Red, Blue, Green, Gray, Clear



AVAILABLE IN CLEAR

NEW COLOR



PRODUCT HIGHLIGHTS

- **FUNCTIONAL** – Reusable shipping, distribution, order picking and storage containers
- **SECURE** – Attached lids snap securely closed to protect contents from dust and damage
- **STACKABLE and NESTABLE** – Containers stack on closed lids and nest in open lids
- **INTERWORKING** – Containers interwork for easy pallet loading
- **VARIETY** – 6 sizes and 5 colors. See the chart below for color options per model
- **CUSTOMIZE** – Custom colors and hot stamping available

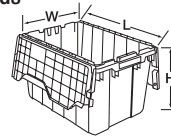

Attached Lid Containers (ALCs)		Outside Dimensions (In.)			Inside Dimensions Top (In.)			Inside Dimensions Bottom (In.)		Capacity/Qty.					Accessories
Model No.	Available Colors	L	W	H	L	W	H	L	W	Cu. Ft.	Gal.	Lbs.	Container Ctn. Qty.	Stack Cap./Qty. Stacked	Steel Dollies
A39085	Blue, Gray, Clear	21-1/2	15	9	19-3/4	14-1/2	8-5/8	18-7/16	13-1/4	1.12	8.5	35	6	35 lbs./5	RU843HR1420
A39120	Blue, Green, Red, Gray, Clear	21-1/2	15	12-1/2	19-3/4	14-1/2	12	18-7/16	13-1/4	1.62	12	65	6	65 lbs./5	RU843HR1420
A39170	Blue, Gray, Clear	21-1/2	15	17	19-3/4	14-1/2	16-7/8	18-7/16	13-1/4	2.28	17	100	3	100 lbs./3	RU843HR1420

Order in carton quantities. Specify color when ordering.

KeepBox™

LIGHT-DUTY STORAGE

PRODUCT HIGHLIGHTS

- **FUNCTIONAL** – Secure, dust-free storage
- **NESTABLE** – Containers nest when empty
- **CLEAR** – Sides keep contents visible
- **REINFORCED** – Hinge pins for years of smooth lid operation



COLOR Blue/Clear



KeepBox		Outside Dimensions (In.)			Inside Dimensions Top (In.)			Inside Dimensions Bottom (In.)		Capacity/Qty.				
Model No.	Description	L	W	H	L	W	H	L	W	Cu. Ft.	Gal.	Lbs.	Ctn. Qty.	Stack Cap./Qty. Stacked
A66486CLDBL	12 gal. KeepBox	21-1/2	15	12-1/2	19-3/4	14-1/2	12	17-7/8	12-3/4	1.6	12	25	6	5

Order in carton quantities.

Gas Cans : Fuel Containers

Fuel Cans

Scepter gas cans are manufactured from high density polyethylene providing a safe, noncorrosive, reliable alternative for filling gas powered engines.



03615SCP

07081SCP

07079SCP

06922SCP

03609SCP



06922SCP



06792SCP



08340SCP

Gas Cans		Color	Outside Dimensions (In.)			Case Qty.
Model No.	Description		L	W	H	
03609SCP	20L Military Style Gas Can	RED	13.3	18.3	4	48
03615SCP	Oil/Gas Combo 6L Gas + 2.5L Oil Can	RED	13	11	6	24
06792SCP	Flo N Go 53L 14G Duramax Wheeled Can	RED	16.2	33.8	4	12
06922SCP	Flo N Go Max Flo Combo w/ 25L Gas Can	RED	14.8	17.2	3	10
07079SCP	2.5G / 10L Gas Can	RED	11.8	11.5	7.4	1
07081SCP	1.25G / 5L Gas Can	RED	8.8	10	15.8	12
07622SCP	5.5G / 20L Gas Can	RED	14.8	14.5	18	4
08340SCP	Flo N Go Super Flo Combo w 10L Gas Can	RED	11.7	12	20	1

Diesel, Water & Kerosene Cans



07624SCP

07649SCP

04933SCP

03711SCP

Diesel, Water, Kerosene Containers			Outside Dimensions (In.)			Case Qty.
Model No.	Description	Color	L	W	H	
03711SCP	20L Military Style Diesel Can	YELLOW	13.3	18.3	7.3	4
04933SCP	20L Military Style Water Container	BLUE	13.3	18.3	7.3	4
07624SCP	20L Kerosene Can	BLUE	14.8	14.5	11.3	8
07649SCP	20L Diesel Container	YELLOW	14.8	14.5	9.8	4

Fuel Siphon/Pumps : Funnels : Drain Pans

Container Accessories



Container Accessories		Color	Outside Dimensions (In.)			Case Qty.
Model No.	Description		L	W	H	
03583SCP	Jerry Can Multipack Kit	YELLOW	11.3	1.3	6.5	8
03603SCP	Multi Use Flexible Funnel	BLACK	6.3	16.5	5.8	4
03629SCP	Flexible Spout	YELLOW	11.3	1	8	12
03647SCP	Jerry Can Spare Parts Kit	YELLOW	11.3	2	12	12
05459SCP	Spill Proof Eco Spout	YELLOW	11.3	2.3	4.9	12
08045SCP	12" Funnel	BLACK	12	13	12.8	4
08338SCP	Flo N Go Max Flo Siphon Pump	RED	13.8	3	8	12
08499SCP	Jerry Can Stoppers	YELLOW	11.3	1.8	20	1
08672SCP	Multi Purpose Funnel	BLACK	3.5	10.5	20.3	10
09644SCP	Flo N Go Fluid Extraction System	WHITE	11.3	15.3	20.3	10
10454SCP	Trigger Flo	RED/BLACK	6	2	10	12



Drain Pans



Drain Pans		Color	Outside Dimensions (In.)			Case Qty.
Model No.	Description		L	W	H	
03896SCP	7.5L Drain Pan	BLACK	16.3	4	3.9	12
06985SCP	19L Square Drain Pan	BLACK	21	6	10.4	1
07029SCP	6.6L Drain Container	BLACK	12.5	5.8	10.8	10



Flammable Safety Cabinets

Slimline Safety Flammable Cabinets

- All welded double wall 18 gauge construction with 1-1/2" insulating air space.
- 2" leakproof sill to contain leaks.
- Lockable flush mounted handle with 2 keys.
- Door has 3 point locking system and radius edges.
- Door is double walled, 14 gauge outside & 18 gauge inside.
- 4" heavy duty welded hinges with brass pins.
- Galvanized steel shelves, adjust on 3" centers.
- Twin 2" flame arrester vents.
- Adjustable leveling feet.
- Powder coated yellow finish.
- Safety signage in large red letters.
- Grounding connector.
- Meets OSHA, and NFPA code 30.
- Manual close door opens 180°.
- Chemical storage maximum - Class I & II - 60 gallons, Class III - 120 gallons.



BA06-YP



BA12-YP

Slimline Safety Cabinets					Outside Dimensions (In.)			
Model No.	Description	# Adj. Shelves	# of Doors	Capacity (Gal.)	W	D	H	WT.
BA06-YP	6 Gal. Flammable Cabinet	0	1	6	23	18	22	88
BA12-YP	12 Gal. Flammable Cabinet	1	1	12	23	18	35	136

Standard Safety Flammable Cabinets

- All sizes are FM Approved!
- All welded double wall 18 gauge construction with 1-1/2" insulating air space.
- Doors are double walled, 14 gauge outside & 18 gauge inside.
- 2" leakproof sill to contain leaks.
- Lockable flush mounted handle with 2 keys.
- Doors have 3 point locking system and radius edges.
- 4" heavy duty welded hinges with brass pins.
- Twin 2" flame arrester vents.
- Adjustable leveling feet and grounding connector.
- Powder coated yellow finish.
- Safety signage in large red letters.
- Galvanized steel shelves adjust on 3" centers.
- Meets OSHA, and NFPA code 30 standards.
- 2 Doors - Manual close doors (open to full 180°).
- Chemical storage maximum - Class I & II - 60 gallons, Class III - 120 gallons



BM45-YP



BM90-YP



BM30-YP

Standard Safety Cabinets					Outside Dimensions (In.)			
Model No.	Description	# Adj. Shelves	# of Doors	Capacity (Gal.)	W	D	H	WT.
BM30-YP	30 Gal. Flammable Cabinet	1	2	30	43	18	44	250
BM45-YP	45 Gal. Flammable Cabinet	2	2	45	43	18	65	357
BM60-YP	60 Gal. Flammable Cabinet	2	2	60	34	34	65	438
BM90-YP	390 Gal. Flammable Cabinet	2	2	90	43	34	65	500

Trays

FEATURES

- Tongue-and-groove design for positive, secure tray stacking
- Low walls for easy product access
- Two-way or four-way hand truck entry allows for accessibility and convenient moving and loading
- Open-grid bottom and open sides allow maximum air flow for product ventilation
- Stack and nest within footprints to eliminate wasted space and reduce backhaul space
- Allow full cube of trailers, reducing transport costs
- Combine with plastic or steel dollies for easy transport of bakery or sweet goods
- Molded of HDPE; will not corrode or splinter
- Freezer-safe
- Use with temperatures of -20° to 120° F
- Customization and identification options available
- 100% recyclable



BA23200422000



C19702E03



C19932E



BA29260684



BA26220777



BT28220722



BT28220522



BA26220622

Trays			Dimensions						
Primary Model No.	Secondary Model No.	Colour	Description	Outside	Inside	Pallet QTY	Nesting Ratio	Wt. lbs.	Cap. lbs.
BA23200422000	019701E	GREY	SINGLE LEVEL TRAY 90 DEGREE NEST	23" x 20.31" x 3.63"	22" x 19.44" x 2.88"	240	2:1	2.5	10
C19702E03	BA26220322	BLUE	SINGLE LEVEL TRAY 90 DEGREE NEST	26" x 21.75" x 3.44"	24.75" x 20.75" x 2.69"	84	2:1	2.67	10
C19703E03	BA26220522	BLUE	SINGLE LEVEL TRAY 90 DEGREE NEST	26" x 21.75" x 4 5/8"	24.75" x 20.75" x 3.6"	84	2:1	2.75	10
BA2622077705000	C19704E05	BEIGE	SINGLE LEVEL TRAY 90 DEGREE NEST	26" x 21 3/4" x 6.56"	24.75" x 20.75" x 5.50"	74	2:1	4.13	20
C19706E	BA26220622	BEIGE	SINGLE LEVEL TRAY 90 DEGREE NEST	26 3/4" x 22 1/4" x 5 3/4"	25.75" x 21.25" x 5"	70	2:1	3.5	18
BA29260684		BEIGE	SINGLE LEVEL TRAY 90 DEGREE NEST	29" x 26" x 6.13"	27.75" x 24.75" x 5.31"		2:1	5.4	20
BT28220522		BLUE	SINGLE LEVEL TRAYS 180 DEGREE NEST	28 5/16" x 22" x 4 3/4"	25" x 20.38" x 3.69"		2:1:1	3.9	30
BT28220722		RED	SINGLE LEVEL TRAYS 180 DEGREE NEST	28 5/16" x 22" x 6 3/4"	24.75" x 20.19" x 5.69"		3:1	4.6	30
MULTI-LEVEL									
C19932E	BL27230623	Min Order	MULTI-LEVEL TRAY	27.44" x 23.44" x 5.5"	24.88" x 22.5" x 5.19"		2.6:1	5.5	20

Product Index

MATERIAL HANDLING : STORAGE : TRANSPORT PRODUCTS

79532	103	A10164	50	A30230ESD	9	A305A3	8	A30900	84
79564	103	A10454SCP	113	A30231CRY	5	A305A4	8	A30902	84
79596	103	A13014	12	A30232	5	A305A5	8	A30906	84
007-640	25	A13017	12	A30233CRY	5	A305A6	8	A30930	84
007-641	25	A13018	12	A30234	5	A305B1	8	A30936	84
007-644	25	A17018	48	A30235	5	A305B2	8	A30936	84
007-648	25	A19109	48	A30235ESD	9	A30600BRACKET	32	A31112	21
007-670	25	A19228	48	A30236CRY	5	A30600DOLLY	32	A31118	21
007-671	25	A19320	48	A30237	5	A30606DOLLY	37	A31142	21
007-678	25	A19416	48	A30239	5	A30606GY	37	A31148	21
019701E	115	A19715	48	A30240	5	A30606GY240	37	A31162	21
075-611	103	A19909	48	A30240ESD	9	A30606GY250	37	A31164	21
35R	74	A20228	48	A30242	5	A30606GYASST	37	A31168	21
3P	74	A20320	48	A30243CRY	5	A30607GY	37	A31182	21
3R	74	A20416	48	A30250	5	A30607GY240	37	A31188	21
4P	74	A20715	48	A30255	5	A30607GY250	37	A31620	32
4R	74	A20909	48	A30260	5	A30607GYASST	37	A31625	32
4Rx	74	A29200	13	A30265	5	A30618	35	A31625RACK	32
5P	74	A29201	13	A30270	5	A30632	35	A33011	27
5R	74	A29202	5	A30280	11	A30635AGY	36	A33023	27
A02420	45	A29203	5	A30280L	11	A30635GY	36	A33061	27
A03583SCP	113	A29300	13	A30281	11	A30636	35	A33103	27
A03603SCP	113	A29301	5	A30281L	11	A30636BEIGE1	35	A33105	27
A03609SCP	112	A29302	5	A30282	11	A30636BEIGE3	35	A33162	27
A03615SCP	112	A29303	5	A30282L	11	A30636BEIGE5	35	A33164	27
A03629SCP	113	A29304	11	A30283	11	A30636BEIGEB1	35	A33165	27
A03647SCP	113	A29306	14	A30283L	11	A30637	40	A33166	27
A03711SCP	112	A29308	14	A30284	11	A30637A	40	A33168	27
A03896SCP	113	A30008	33	A30286	11	A30638	35	A33220	27
A04933SCP	112	A30010	17	A30286L	11	A30650GY	37	A33222	27
A05459SCP	113	A30014	17	A30287	11	A30650GY240	37	A33223	27
A05705	44	A30016	49	A30288	11	A30650GY250	37	A33224	27
A05805	44	A30018	17	A30288MOB	11	A30650GYASST	37	A33226	27
A05905	44	A30040	17	A30289	11	A30651	35	A33228	27
A06115	44	A30044	17	A30289MOB	11	A30652	40	A34240	30
A06118	44	A30048	17	A30290	11	A30653	35	A34301	30
A06702	47	A30080	17	A30290L	11	A30653DOLLY	35	A34302	30
A06702CUP	47	A30084	17	A30290MOB	11	A30655	35	A34303	30
A06703	47	A30088	17	A30292	11	A30656GY	37	A34304	30
A06703CUP	47	A30090	17	A30292MOB	11	A30656GY240	37	A35010	24
A06704	47	A30094	17	A30293	11	A30656GY250	37	A35011	24
A06704CUP	47	A30098	17	A30293MOB	11	A30656GYASST	37	A35180	24
A06705	47	A30101	16	A30312	22	A30658	35	A35181	24
A06705CUP	47	A30102	16	A30318	22	A30661	35	A35185	24
A06706	47	A30110	16	A30320	5	A30661DOLLY	35	A35190	24
A06706CUP	47	A30111	36	A30321	5	A30676	35	A35191	24
A06709	47	A30112	36	A30348BEIGE	9	A30716BLACK	22	A35195	24
A06709CUP	47	A30118	35	A30358BEIGE	9	A30718BLACK	22	A35200	24
A06792SCP	112	A30120	16	A30424	33	A30776BLACK	22	A35201	24
A06922SCP	112	A30124	16	A30536	39	A30778BLACK	22	A35225	24
A06985SCP	113	A30128	16	A30536210S	39	A30796BLACK	22	A35230	24
A07029SCP	113	A30130	16	A30536220S	39	A30800	19	A35231	24
A07079SCP	112	A30138	16	A30536230S	39	A30804	19	A35240	24
A07081SCP	112	A30148	33	A30536235S	39	A30806	19	A35241	24
A07622SCP	112	A30150	16	A30536320S	39	A30808	19	A35300	24
A07624SCP	112	A30158	16	A30536A1	39	A30812	33	A35301	24
A07649SCP	112	A30161	35	A30536A3	39	A30814	19	A36110	7
A08045SCP	113	A30164	16	A30536A5	39	A30818	19	A36111CRY	7
A08338SCP	113	A30170	16	A30536B1	39	A30820	19	A36120	7
A08340SCP	112	A30174	16	A30553	39	A30824	19	A36121CRY	7
A08499SCP	113	A30178	16	A30553210S	39	A30828	19	A36130	7
A08672SCP	113	A30184	16	A30553220S	39	A30840	19	A36131CRY	7
A09185BLUE	45	A30210	5	A30553230S	39	A30844	19	A36140	7
A09185SCALAR	45	A30210ESD	9	A30553235S	39	A30860	19	A36141CRY	7
A09514	45	A30211CRY	5	A30553A1	39	A30864	19	A36220	7
A09644SCP	113	A30220	5	A30553A3	39	A30866	19	A36221CRY	7
A09912	45	A30220ESD	9	A30553A5	39	A30868	19	A36230	7
A10116	50	A30221CRY	5	A30553B1	39	A30880	19	A36231CRY	7
A10124	50	A30224	5	A30553LF	39	A30884	19	A36240	7
A10126	50	A30225CRY	5	A305A1	8	A30886	19	A36241CRY	7
A10144	50	A30230	5	A305A2	8	A30888	19	A36442BLKRED	20

Product Index

MATERIAL HANDLING : STORAGE : TRANSPORT PRODUCTS

A36442BLUE	20	A40321	5	A42223	27	AC2115090204000	110	AD3511C62	56
A36448BLKRED	20	A40348	9	A42224	27	AC21151202	110	AD3511C82	56
A36448BLUE	20	A40358	9	A42226	27	AC3618	52	AD3511CAST2	56
A36462BLKRED	20	A40410	15	A42228	27	AC3618KD1ASY	51	AD3511P	56
A36462BLUE	20	A40411	15	A45612	60	AC3618KD4AS	51	AD3511P62	56
A36468BLKRED	20	A40412	15	A45618	60	AC3618QV	53	AD3511PAST2	56
A36468BLUE	20	A40416	48	A45624	60	AC3618QV240	53	AD3517BSC	56
A37208	29	A40442	20	A46110	7	AC3618QV250	53	AD3517BSP	56
A37278	29	A40462	20	A46220	7	AC3618QVTVA1	54	AD3517C	56
A37288	29	A40599	5	A48300	28	AC3618QVTVA2	54	AD3517C68	56
A37608	29	A405A1	8	A48301	28	AC3618RT	51	AD3517C88	56
A37612	29	A405A3	8	A66486CLDBL	111	AC3618SHELF1PK	51	AD3517CAST	56
A37616	29	A405A5	8	A76460	94	AC3618SHELF4PK	52	AD3517CAST2	56
A37672	29	A405B1	8	A76461	94	AC3618SV	53	AD3517P	56
A37676	29	A40703	47	A76490	94	AC3618SV240	53	AD3517P68	56
A37678	29	A40704	47	A76491	94	AC3618SV250	53	AD3517P88	56
A37682	29	A40715	48	A76590	94	AC3618Y	52	AD3517PAST	56
A37686	29	A40716	50	A76591	94	AC3624	52	AD3517PAST2	56
A37688	29	A40717	50	A77405FGREY	94	AC36243AS	52	AG191405	25
A38004RED	28	A40800	19	A77405GREY	94	AC3624SHELF3PUT	52	AG201604	25
A38008YEL	28	A40800CRY	19	A77405GREYDP	94	AC3624Y	52	AG201605	25
A38358GRY	28	A40818	19	A77405GREYTB	94	AC3624Y3AS	52	AG24160752	25
A39085	111	A40818CRY	19	A77410FGREY	94	AC3624YD	52	AKW210	23
A39120	111	A40820	19	A77410GREY	94	AC3624YD3AS	52	AKW220	23
A39170	111	A40820CRY	19	A77410GREYDP	94	AC803618M26	51	AKW230	23
A40000	14	A40840	19	A77410GREYTB	94	AC803624M26	52	AKW235	23
A40020	17	A40840CRY	19	A77505FGREY	94	ACKEY	51	AKW239	23
A40020CRY	17	A40860	19	A77505GREY	94	ACKEYF	52	AKW240	23
A40030	17	A40860CRY	19	A77505GREYDP	94	ACQV4C	55	AKW250	23
A40030CRY	17	A40880	19	A77505GREYTB	94	ACQV4C42	55	APRBENCH	41
A40040	17	A40880CRY	19	A77510FGREY	94	ACQV4C62	55	APRBENCH010	41
A40040CRY	17	A40909	48	A77510GREY	94	ACQV4C82	55	APRBENCH040	41
A40050	17	A41103	27	A77510GREYDP	94	ACQV4CAST	55	APRBENCH090	41
A40050CRY	17	A41105	27	A77510GREYTB	94	ACQV4P	55	APRBENCH120	41
A40120	16	A41162	27	A77610FGREY	94	ACQV4P42	55	APRBENCH150	41
A40130	16	A41164	27	A77610GREY	94	ACQV4P62	55	APRBENCH312	41
A40150	16	A41165	27	A77610GREYDP	94	ACQV4P82	55	APRD	41
A40170	16	A41166	27	A77610GREYTB	94	ACQV4PAST	55	APRD010	42
A40210	5	A41168	27	A77710FGREY	94	ACS4C	55	APRD040	42
A40210CRY	5	A41220	27	A77710GREY	94	ACS4C42	55	APRD080	42
A40220	5	A41222	27	A77710GREYDP	94	ACS4C62	55	APRD090	42
A40220CRY	5	A41223	27	A77710GREYTB	94	ACS4C82	55	APRD110	42
A40224	5	A41224	27	A77810FGREY	94	ACS4CAST	55	APRD112	42
A40224CRY	5	A41226	27	A77810GREY	94	ACS4P	55	APRD120	42
A40228	48	A41228	27	A77810GREYDP	94	ACS4P42	55	APRD130	42
A40230	5	A41230	5	A77810GREYTB	94	ACS4P62	55	APRD142	42
A40230CRY	5	A41250	5	A96352A	44	ACS4P82	55	APRD150	42
A40234	5	A41270	5	A96352B	44	ACS4PAST	55	APRD162	42
A40234CRY	5	A41284	11	A98100	50	AD1811C	57	APRD170	42
A40237	5	A41286	11	A98101	50	AD1811C62	57	APRD18	41
A40237CRY	5	A41287	11	A98318GY	38	AD1811C82	57	APRD18018	43
A40239	5	A41288	11	A98318GY2055	38	AD1811CAST	57	APRD18048	43
A40239CRY	5	A41289	11	A98318GY2430	38	AD1811P	57	APRD18088	43
A40245	5	A41410	21	A98325	49	AD1811P62	57	APRD18098	43
A40245CRY	5	A41440	21	A98400	33	AD1811P82	57	APRD18118	43
A40260	5	A41460	21	A98536	39	AD1811PAST	57	APRD18128	43
A40260CRY	5	A41480	21	A98536210SD	39	AD1817C	57	APRD18138	43
A40265	5	A415A1	8	A98536210SS	39	AD1817C68	57	APRD18148	43
A40265CRY	5	A415B1	8	A98536220SD	39	AD1817C88	57	APRD18158	43
A40270	5	A41814	19	A98536220SS	39	AD1817CAST	57	APRD18168	43
A40270CRY	5	A41818	19	A98536230SD	39	AD1817P	57	APRD18178	43
A40280	11	A41820	19	A98536230SS	39	AD1817P68	57	APRD18188	43
A40281	11	A42103	27	A98536235SD	39	AD1817P88	57	APRD182	42
A40282	11	A42105	27	A98536235SS	39	AD1817PAST	57	APRD18318	43
A40286	11	A42162	27	A98536320SD	39	AD2311C	57	APRD1836448	43
A40287	11	A42164	27	A98536320SS	39	AD2311C62	57	APRD1836468	43
A40289	11	A42165	27	A98600	38	AD2311P	57	APRD18AST00	43
A40290	11	A42166	27	A98636	38	AD2311P62	57	APRD18MOBILE	41
A40292	11	A42168	27	AC11020E06BC	25	AD3511BSC	56	APRD312	42
A40312	22	A42220	27	AC11037E15	25	AD3511BSP	56	APRD36442B	42
A40320	48	A42222	27	AC2115090201000	110	AD3511C	56	APRD36462B	42

Product Index

MATERIAL HANDLING : STORAGE : TRANSPORT PRODUCTS

APRDAST	42	AS1879138	69	AW24SPBKT	60	AWS183630270	64	AWS541836SU	61
APRDAST00	42	AS1879158	69	AW24SWBKT	60	AWS183630318	66	AWS541848SU	61
APRDMOBILE	41	AS1879178	69	AW3660LINER	59	AWS183630808	65	AWS541860SU	61
APRS	41	AS187930808	70	AW3672LINER	59	AWS183630818	65	AWS541872SU	61
APRS010	42	AS187930818	70	AWCART18362	63	AWS183630838	65	AWS542424SU	61
APRS040	42	AS187930838	70	AWCART18363	63	AWS183630848	65	AWS542436SU	61
APRS080	42	AS187930848	70	AWCART24362	63	AWS183630868	65	AWS542448SU	61
APRS090	42	AS187930868	70	AWCART24363	63	AWS183630888	65	AWS542460SU	61
APRS110	42	AS187930888	70	AWCART24482	63	AWS183633166	66	AWS542472SU	61
APRS112	42	AS1879318	70	AWCART24483	63	AWS183633168	66	AWS543648SU	61
APRS120	42	AS187936	67	AWCLAMP2PK	59	AWS183635180	66	AWS543660SU	61
APRS130	42	AS187936448B	70	AWCLIP4PK	59	AWS183636448B	65	AWS543672SU	61
APRS142	42	AS187936468B	70	AWDIVIDER12	60	AWS183636468B	65	AWS631224SU	61
APRS150	42	AS187942	67	AWDIVIDER18	60	AWS1836M34301	66	AWS631236SU	61
APRS162	42	AS1879ASORT	69	AWDIVIDER24	60	AWS1836SHELF	58	AWS631248SU	61
APRS170	42	AS2213120201000	110	AWDIVIDER36	60	AWS1836SL	59	AWS631436SU	61
APRS18	41	AS2479	67	AWDONUT	59	AWS1836SLMU	63	AWS631824SU	61
APRS18018	43	AS2479014	69	AWFOOTLEVEL4PK	59	AWS1836SNS	64	AWS631830SU	61
APRS18048	43	AS2479044	69	AWFOOTPLATE4PK	59	AWS184813017	64	AWS631836SU	61
APRS18088	43	AS2479084	69	AWLEDGE12	60	AWS184830260	64	AWS631848SU	61
APRS18098	43	AS2479094	69	AWLEDGE18	60	AWS184830280	64	AWS631860SU	61
APRS18118	43	AS2479284	68	AWLEDGE24	60	AWS184830281	64	AWS631872SU	61
APRS18128	43	AS2479287	68	AWLEDGE36	60	AWS184830282	64	AWS632424SU	61
APRS18138	43	AS2479288	68	AWLEDGE48	60	AWS184830283	64	AWS632436SU	61
APRS18148	43	AS247930804	70	AWLEDGE60	60	AWS1848SAB	64	AWS632448SU	61
APRS18158	43	AS247930814	70	AWLEDGE72	60	AWS1848SHELF	58	AWS632460SU	61
APRS18168	43	AS247930844	70	AWP34UPRIGHT	58	AWS1848SL	59	AWS632472SU	61
APRS18178	43	AS247930864	70	AWP54UPRIGHT	58	AWS1848SLMU	63	AWS633648SU	61
APRS18188	43	AS247930884	70	AWP63UPRIGHT	58	AWS1860SHELF	58	AWS633660SU	61
APRS182	42	AS2479ASSORT	68	AWP74UPRIGHT	58	AWS1872SHELF	58	AWS633672SU	61
APRS18318	43	AS2821150201000	110	AWP86UPRIGHT	58	AWS2424SHELF	58	AWS741224SU	62
APRS1836448	43	AS3424201201000	110	AWP96UPRIGHT	58	AWS24360284	64	AWS741236SU	62
APRS1836468	43	AS3679	67	AWPCAST4	59	AWS24360287	64	AWS741248SU	62
APRS18AST00	43	AS3679292	68	AWPCAST5Y	59	AWS24360288	64	AWS741436SU	62
APRS312	42	AS3679293	68	AWPHDL18	60	AWS24360SAB	64	AWS741824SU	62
APRS36442B	42	AS3679ASSORT	68	AWPHDL24	60	AWS24361288	64	AWS741830SU	62
APRS36462B	42	ASC1279	67	AWPHDL24	60	AWS243630014	65	AWS741836SU	62
APRSAST	42	ASC1279112	68	AWS1236SHELF	58	AWS243630044	65	AWS741848SU	62
APRSAST00	42	ASC1279142	68	AWS1248SHELF	58	AWS243630084	65	AWS741860SU	62
AR15141302	110	ASC1279162	68	AWS143630010	65	AWS243630094	65	AWS741872SU	62
AR15141502	110	ASC1279182	68	AWS143630040	65	AWS243630804	65	AWS742424SU	62
AR2012070201000	110	ASC1279AST	68	AWS143630080	65	AWS243630814	65	AWS742436SU	62
AR24201202	110	ASC1879	67	AWS143630090	65	AWS243630844	65	AWS742448SU	62
AR27170902	110	ASC1879118	68	AWS143630120	64	AWS243630864	65	AWS742460SU	62
AR27171202	110	ASC1879148	68	AWS143630130	64	AWS243630884	65	AWS742472SU	62
AS1279	67	ASC1879168	68	AWS143630150	64	AWS2436SHELF	58	AWS743648SU	62
AS1279010	69	ASC1879188	68	AWS143630170	64	AWS2436SL	59	AWS743660SU	62
AS1279040	69	ASC1879AST	68	AWS143630240	64	AWS2436SLMU	63	AWS743672SU	62
AS1279080	69	AW1224LINER	59	AWS143630250	64	AWS244830124	64	AWS861224SU	62
AS1279090	69	AW1236LINER	59	AWS143630312	66	AWS244830164	64	AWS861236SU	62
AS1279110	69	AW1248LINER	59	AWS143630320	64	AWS244830174	64	AWS861248SU	62
AS1279120	69	AW1824LINER	59	AWS143630800	65	AWS244830184	64	AWS861436SU	62
AS1279130	69	AW1836FRAME	59	AWS143630840	65	AWS244830348BE	64	AWS861824SU	62
AS1279150	69	AW1836LINER	59	AWS143630860	65	AWS244837608	66	AWS861830SU	62
AS1279170	69	AW1848FRAME	59	AWS143630880	65	AWS2448SHELF	58	AWS861836SU	62
AS127930800	70	AW1848LINER	59	AWS143636442B	65	AWS2448SL	59	AWS861848SU	62
AS127930840	70	AW1860LINER	59	AWS143636462B	65	AWS2448SLMU	63	AWS861860SU	62
AS127930860	70	AW1872LINER	59	AWS1436SHELF	58	AWS246035225	66	AWS861872SU	62
AS127930880	70	AW18DPBKT	60	AWS1824SHELF	58	AWS2460M30358	64	AWS862424SU	62
AS1279312	70	AW18DWBKT	60	AWS1830SHELF	58	AWS2460M34240	66	AWS862436SU	62
AS127936442B	70	AW18SPBKT	60	AWS183613014	64	AWS2460SHELF	58	AWS862448SU	62
AS127936462B	70	AW18SWBKT	60	AWS183613018	64	AWS2472SHELF	58	AWS862460SU	62
AS1879	67	AW2424LINER	59	AWS183630018	65	AWS3648SHELF	58	AWS862472SU	62
AS1879018	69	AW2436FRAME	59	AWS183630048	65	AWS3660SHELF	58	AWS863648SU	62
AS1879048	69	AW2436LINER	59	AWS183630088	65	AWS3672SHELF	58	AWS863660SU	62
AS1879088	69	AW2448FRAME	59	AWS183630098	65	AWS541224SU	61	AWS863672SU	62
AS1879098	69	AW2448LINER	59	AWS183630128	64	AWS541236SU	61	AWSH00K8PK	59
AS1879128	69	AW2460LINER	59	AWS183630138	64	AWS541248SU	61	AWUHDL18	60
AS187913014	69	AW2472LINER	59	AWS183630158	64	AWS541436SU	61	AWUHDL24	60
AS187913017	69	AW24DPBKT	60	AWS183630178	64	AWS541824SU	61	BA06-YP	114
AS187913018	69	AW24DWBKT	60	AWS183630265	64	AWS541830SU	61	BA12-YP	114

Product Index

MATERIAL HANDLING : STORAGE : TRANSPORT PRODUCTS

BA23200422000	115	BA26220322	115	BA26220522	115	BA26220622	115	BA2622077705000	115	BA29260684	115	BF4229280010000	107	BF42292800SG000	107	BF4844290010000	107	BF48442900SG000	107	BF484515XP23000	107	BF484519XP23000	107	BG4840332063002	105	BG4840460251001	105	BH4840252010000	105	BH4840342010000	105	BH4845252010000	105	BH4845342010000	105	BI4840342010000	105	BI4840392010000	105	BL27230623	115	BM30-YP	114	BM45-YP	114	BM60-YP	114	BM90-YP	114	BN3230252010000	105	BN3230342010000	105	BN4845252010000	105	BN48453420	103	BN4845342010000	105	BN4845342023000	105	BN4845352010000	105	BN4845392010000	105	BN4845412010000	105	BN4845442010000	105	BN4845512010000	105	BT28220522	115	BT28220722	115	BZ4840460005000	107	BZ4840460V	107	BZ48404610	107	BZ4840461T	107	BZ4840461V	107	BZ484046T051000	107	BZ4844470VU1000	107	C18-525E05	110	C18-541E05	110	C18-702E	25	C19702E03	115	C19703E03	115	C19704E05	115	C19706E	115	C19932E	115	CF574500650010143	107	CPP100ACM	108	CPP100CPE	108	CPP100PE	108	CPP103PE	108	CPP200ACM	108	DL2115090201000	110	DL2420120201000	110	DR2115010001000	110	DR2420010001000	110	DY22190700	71	DY282305M509000	71	DY3027040099000	71	DY48400900	71	DY48450900	71	ECOUS5CD3R	108	ECOUS5CD6RM	108	ECOUS5OD3R	108	ECOUS5OD6RM	108	GH4840412010100	105	GL4840412010100	105	GP4840412010100	105	HD4824A	51	HD4824ABE	54	HD4824ACH	54	HD4824E	51	HD4824F	51	HD4824MCLAR	51	HD4824TVABBE	54	HD4824TVABCH	54	HD4824TVBE	54	HD4824TVCH	54	HSNDIV210LAK	23	HSNDIV220LAK	23	HSNDIV220WAK	23	HSNDIV230LAK	23	HSNDIV235WAK	23	HSNDIV239LAK	23	HSNDIV240WAK	23	HSNDIV250LAK	23	HSNDIV250WAK	23	JL25160800	30	LJ251602000	30	LPP3NL	36	LPP3SP	36	LPP3WL	36	LPP6NL	36	LPP6SP	36	LPP6WL	36	LVDMOBILE	35	MA3618BLD	87	MA3618BLD1	87	MA3618C	86	MA3618C1	86	MA3618C2	86	MA3618CAST	86	MA3618CLD	87	MA3618CLD1	87	MA3618P	86	MA3618P1	86	MA3618P2	86	MA3618PAST	86	MA3618PLD	87	MA3618PLD1	87	MA4824BLD	87	MA4824BLD1	87	MA4824BLD2	87	MA4824BLD3	87	MA4824C	86	MA4824C1	86	MA4824C2	86	MA4824C3	86	MA4824CLD	87	MA4824CLD1	87	MA4824CLD2	87	MA4824CLD3	87	MA4824P	86	MA4824P1	86	MA4824P2	86	MA4824P3	86	MA4824PLD	87	MA4824PLD1	87	MA4824PLD2	87	MA4824PLD3	87	PD4840060010000	108	PL4840060026000	108	PL4840073226000	108	PM3230063210000	108	PM4848060010004	108	PN4845063310000	108	PO4845063210000	108	PU4840063310006	108	PW484062210000	108	PW4845062210000	108	R1130BRK	74	R1151BRK	74	R1495	74	R1B5HR	89	R1B5HRL	89	R1B5HRX	89	R1B5HRXL	89	R1S10FP2	88	R1S5HR	88	R1S5HR2LD	88	R1S8FP2	88	R1S8MR	88	R1S8MR2	88	R2108FPB	77	R2125MRB	77	R214CS1841	89	R214CS1859	89	R214CS1878	89	R214CS2841	89	R214CS2859	89	R214CS2878	89	R2168MRB	77	R216CS2236	89	R216CS2239	89	R216CS2836	89	R2178MRB	77	R219885MRB	77	R221812MRB	77	R2258516MRB	77	R2ST5HR	88	R2T5HR1830	89	R2T5HR2436	89	R2T5HR2448	89	R2T8MR2448	89	R3008MR	92	R3010FP	92	R3010SP	92	R3ST5HR	88	R4008MR	92	R4008MR2	92	R4010FP	92	R4010FP2	92	R4010SP	92	R4010SP2	92	R4510SP	92	R4510SP2	92	R4ST5HR	88	R4ST8MR	88	R5ST5HR	88	R5ST8MR	88	R5SYT5HR2436	88	R5SYT5HR3636	88	R5SYT8MR2436	88	R5SYT8MR3636	88	R90110A1411	79	R90110A1412	79	R90110B2412	79	R90110F44813	79	R90110S2411	79	R90162A1411	79	R90162A1412	79	R90162D3815	79	R90162P24111811	79	R90163A1411	79	R90163A1412	79	R90163D3815	79	R90163F44813	79	R90163P24111811	79	R90165A1411	79	R90165A1412	79	R90165B2412	79	R90165S2411	79	R90181A1411	79	R90181A1412	79	R90181B2412	79	R90181D3815	79	R90181F44813	79	R90181P24111811	79	R90181S2411	79	R90182A1411	79	R90182A1412	79	R90182B2412	79	R90182D3815	79	R90182F44813	79	R90182P24111811	79	R90182S2411	79	R90184A1411	79	R90184A1412	79	R90184B2412	79	R90184F44813	79	R90184S2411	79	R90185A1411	79	R90185A1412	79	R90210A1011	79	R90210A1012	79	R90210B2012	79	R90210F40013	79	R90210S2011	79	R90262A1011	79	R90262A1012	79	R90262D3015	79	R90262P20111011	79	R90263A1011	79	R90263A1012	79	R90263D3015	79	R90263F40013	79	R90263P20111011	79	R90265A1011	79	R90265A1012	79	R90265B2012	79	R90265S2011	79	R90281A1011	79	R90281A1012	79	R90281B2012	79	R90281D3015	79	R90281F40013	79	R90281P20111011	79	R90281S2011	79	R90282A1011	79	R90282A1012	79	R90282B2012	79	R90282D3015	79	R90282F40013	79	R90282P20111011	79	R90282S2011	79	R90284A1011	79	R90284A1012	79	R90284B2012	79	R90284F40013	79	R90284S2011	79	R90285A1011	79	R90285A1012	79	RA3JLR3POGY	31	RA3JLR3TPGY	31	RA3JLR4MRGY	31	RA3JLR5SRGY	31	RA6JLR3POGY	31	RA6JLR3TPGY	31	RA6JLR4MRGY	31	RA6JLR5SRGY	31	RA6JLR5TPGY	31	RA6JLR6MRGY	83	RA778MR	83	RACR30806	19	RACR30826	19	RACR5MR	30	RC25141401	103	RCT40LW	92	RCTV40SP	92	RD2416F3P	74	RD2416R3P	74	RD2416S3P	74	RD2718F3P	74	RD2718RC3P	74	RD2718S3P	74	RD3018AC3P	74	RD3018CE3P	74	RD3018F3P	74	RD3018R3P	74	RD3018RC3P	74	RD3018S3P	74	RD3018S3P	74	RD3624AC3P	74	RD3624CE3P	74	RD3624F3P	74	RD3624R3P	74	RD3624S3P	74	RD4824F3P	74	RD4824S3P	74	RD843HR	72	RD843SS	72	RD844HR	72	RD844SS	72	RD853HR	72	RD853SS	72	RD854HR	72	RD854SS	72	RDT4008SP	93	RDT4010FP	93	RDT4010SP	93	RF718MR	83	RGTD10FP	92	RGTD10SP	92	RGTS10FP	92	RGTS10SP	92	RHDLH00K	72	RHWB2448P5PYOG	90	RM718MR	83	RMD2ST5SR	90	RMD3018F4PN	71	RMD3018F4RX	71	RMD3018FN	71	RMD3018RC4PN	71	RMD3018RC4RX	71	RMD3018RCN	71	RMD3018RCN	71	RMD3018RCN	71	RMD35T5SR	90	RMWB24485SRTPG	90	RPT24485J5G6GY	75	RPT24485J5M8GY	75	RPT24485J5N8GY	75	RPT24485J5P6GY	75	RPT24485K5G6GY	75	RPT24485K5M8GY	75	RPT24485K5N8GY	75	RPT24485K5P6GY	75	RPT27545J5G6GY	75	RPT27545J5M8GY	75	RPT27545J5N8GY	75	RPT27545J5P6GY	75
-------------------------	-----	----------------------	-----	----------------------	-----	----------------------	-----	---------------------------	-----	----------------------	-----	---------------------------	-----	---------------------------	-----	---------------------------	-----	---------------------------	-----	---------------------------	-----	---------------------------	-----	---------------------------	-----	---------------------------	-----	---------------------------	-----	---------------------------	-----	---------------------------	-----	---------------------------	-----	---------------------------	-----	---------------------------	-----	----------------------	-----	-------------------	-----	-------------------	-----	-------------------	-----	-------------------	-----	---------------------------	-----	---------------------------	-----	---------------------------	-----	----------------------	-----	---------------------------	-----	---------------------------	-----	---------------------------	-----	---------------------------	-----	---------------------------	-----	---------------------------	-----	---------------------------	-----	----------------------	-----	----------------------	-----	---------------------------	-----	----------------------	-----	----------------------	-----	----------------------	-----	----------------------	-----	---------------------------	-----	---------------------------	-----	----------------------	-----	----------------------	-----	--------------------	----	---------------------	-----	---------------------	-----	---------------------	-----	-------------------	-----	-------------------	-----	-----------------------------	-----	---------------------	-----	---------------------	-----	--------------------	-----	--------------------	-----	---------------------	-----	---------------------------	-----	---------------------------	-----	---------------------------	-----	---------------------------	-----	----------------------	----	---------------------------	----	---------------------------	----	----------------------	----	----------------------	----	----------------------	-----	-----------------------	-----	----------------------	-----	-----------------------	-----	---------------------------	-----	---------------------------	-----	---------------------------	-----	-------------------	----	---------------------	----	---------------------	----	-------------------	----	-------------------	----	-----------------------	----	------------------------	----	------------------------	----	----------------------	----	----------------------	----	------------------------	----	------------------------	----	------------------------	----	------------------------	----	------------------------	----	------------------------	----	------------------------	----	------------------------	----	------------------------	----	----------------------	----	-----------------------	----	------------------	----	------------------	----	------------------	----	------------------	----	------------------	----	------------------	----	---------------------	----	---------------------	----	----------------------	----	-------------------	----	--------------------	----	--------------------	----	----------------------	----	---------------------	----	----------------------	----	-------------------	----	--------------------	----	--------------------	----	----------------------	----	---------------------	----	----------------------	----	---------------------	----	----------------------	----	----------------------	----	----------------------	----	-------------------	----	--------------------	----	--------------------	----	--------------------	----	---------------------	----	----------------------	----	----------------------	----	----------------------	----	-------------------	----	--------------------	----	--------------------	----	--------------------	----	---------------------	----	----------------------	----	----------------------	----	----------------------	----	---------------------------	-----	---------------------------	-----	---------------------------	-----	---------------------------	-----	---------------------------	-----	---------------------------	-----	---------------------------	-----	---------------------------	-----	--------------------------	-----	---------------------------	-----	--------------------	----	--------------------	----	-----------------	----	------------------	----	-------------------	----	-------------------	----	--------------------	----	--------------------	----	------------------	----	---------------------	----	-------------------	----	------------------	----	-------------------	----	--------------------	----	--------------------	----	----------------------	----	----------------------	----	----------------------	----	----------------------	----	----------------------	----	----------------------	----	--------------------	----	----------------------	----	----------------------	----	----------------------	----	--------------------	----	----------------------	----	----------------------	----	-----------------------	----	-------------------	----	----------------------	----	----------------------	----	----------------------	----	----------------------	----	-------------------	----	-------------------	----	-------------------	----	-------------------	----	-------------------	----	--------------------	----	-------------------	----	--------------------	----	-------------------	----	--------------------	----	-------------------	----	--------------------	----	-------------------	----	-------------------	----	-------------------	----	-------------------	----	------------------------	----	------------------------	----	------------------------	----	------------------------	----	-----------------------	----	-----------------------	----	-----------------------	----	------------------------	----	-----------------------	----	-----------------------	----	-----------------------	----	-----------------------	----	---------------------------	----	-----------------------	----	-----------------------	----	-----------------------	----	------------------------	----	---------------------------	----	-----------------------	----	-----------------------	----	-----------------------	----	-----------------------	----	-----------------------	----	-----------------------	----	-----------------------	----	-----------------------	----	------------------------	----	---------------------------	----	-----------------------	----	-----------------------	----	-----------------------	----	-----------------------	----	-----------------------	----	------------------------	----	---------------------------	----	-----------------------	----	-----------------------	----	-----------------------	----	-----------------------	----	------------------------	----	-----------------------	----	-----------------------	----	-----------------------	----	-----------------------	----	-----------------------	----	-----------------------	----	------------------------	----	-----------------------	----	-----------------------	----	-----------------------	----	-----------------------	----	---------------------------	----	-----------------------	----	-----------------------	----	-----------------------	----	------------------------	----	---------------------------	----	-----------------------	----	-----------------------	----	-----------------------	----	-----------------------	----	-----------------------	----	-----------------------	----	-----------------------	----	-----------------------	----	------------------------	----	---------------------------	----	-----------------------	----	-----------------------	----	-----------------------	----	-----------------------	----	-----------------------	----	------------------------	----	---------------------------	----	-----------------------	----	-----------------------	----	-----------------------	----	-----------------------	----	------------------------	----	-----------------------	----	-----------------------	----	-----------------------	----	-----------------------	----	-----------------------	----	-----------------------	----	-----------------------	----	-----------------------	----	-----------------------	----	-----------------------	----	-----------------------	----	-----------------------	----	-----------------------	----	-------------------	----	---------------------	----	---------------------	----	-------------------	----	----------------------	-----	-------------------	----	--------------------	----	---------------------	----	---------------------	----	---------------------	----	---------------------	----	----------------------	----	---------------------	----	----------------------	----	----------------------	----	---------------------	----	---------------------	----	----------------------	----	---------------------	----	---------------------	----	----------------------	----	----------------------	----	---------------------	----	---------------------	----	---------------------	----	---------------------	----	---------------------	----	-------------------	----	-------------------	----	-------------------	----	-------------------	----	-------------------	----	-------------------	----	-------------------	----	-------------------	----	---------------------	----	---------------------	----	---------------------	----	-------------------	----	--------------------	----	--------------------	----	--------------------	----	--------------------	----	--------------------	----	--------------------------	----	-------------------	----	---------------------	----	-----------------------	----	-----------------------	----	---------------------	----	------------------------	----	------------------------	----	----------------------	----	----------------------	----	----------------------	----	---------------------	----	--------------------------	----	--------------------------	----	--------------------------	----	--------------------------	----	--------------------------	----	--------------------------	----	--------------------------	----	--------------------------	----	--------------------------	----	--------------------------	----	--------------------------	----	--------------------------	----	--------------------------	----

Product Index

MATERIAL HANDLING : STORAGE : TRANSPORT PRODUCTS

RPT27545K5G6GY	75	SL1512010006000	109	TS300SC	96	U90181L24112817	81
RPT27545K5M8GY	75	SN20161200	25	TS310E	97	U90182A1411	81
RPT27545K5N8GY	75	SN21141200	25	TS320E	97	U90182A1412	81
RPT27545K5P6GY	75	SN24160800	25	TS3230020010000	107	U90182B2412	81
RPT30605J5G6GY	75	SN24160822	25	TS330E	97	U90182D3817	81
RPT30605J5M8GY	75	SN24161200	25	TS350A	95	U90182G14112817	81
RPT30605J5N8GY	75	SN24161222	25	TS350E	96	U90182H24121817	81
RPT30605J5P6GY	75	SN24161600	25	TS350SC	96	U90182L24112817	81
RPT30605K5G6GY	75	SN24161622	25	TS385	102	U90184A1411	81
RPT30605K5M8GY	75	SOS11	100	TS430B	99	U90184A1412	81
RPT30605K5N8GY	75	SOS18	100	TS4800	100	U90184B2412	81
RPT30605K5P6GY	75	SOS36	100	TS4840020010000	107	U90184G14112817	81
RPT401OSP	93	SOS5.5	100	TS48450300	103	U90184L24112817	81
RSSAKBINHDDWN12	89	SW120705F101000	109	TS4845030010000	107	U90185A1411	81
RSSAKBINHDDWN6	89	SW151205F101000	109	TS4900	100	U90185A1412	81
RSSAKBINHDDWN9	89	SW1512060206000	109	TS519A	101	U90210A1011	81
RU843HR	72	SW151207F101000	109	TS519B	101	U90210A1012	81
RU843HR1420	73	SW151209F101000	109	TS549A	101	U90210B2012	81
RU843HR1422	24, 73	SW2411100206000	109	TS549B	101	U90210G10112017	81
RU843HR1519	73	SW241504A206000	109	TS550	100	U90210L20112017	81
RU843HR1617	73	SW241505F101000	109	TS559A	101	U90262A1011	81
RU843HR1621	27, 73	SW2415060206000	109	TS559B	101	U90262A1012	81
RU843HR1624	73	SW241507F101000	109	TS565	102	U90262D3017	81
RU843HR1822	24, 73	SW241509F101000	109	TS575	102	U90262H20121017	81
RU843HR1828	24, 73	SW241511F101000	109	TS595	102	U90263A1011	81
RU843HR2018	73	SW241514F101000	109	TS750B	99	U90263A1012	81
RU843HR2918	73	SW242207F101000	109	TS7701	103	U90263D3017	81
RU843SS	72	SW242209F101000	109	TS7702	103	U90263H20121017	81
RU843TP1721	73	SW242211F101000	109	TS770B	99	U90263L20112017	81
RU843TP1727	73	SW242214F101000	109	TS840B	97	U90265A1011	81
RU843TP1821	73	SW3215080206000	109	TS850B	97	U90265A1012	81
RU843TP2122	73	SW3215080209000	109	TSEZ-200	103	U90281A1011	81
RU843TP2227	73	SW4815080206000	109	TSEZ-400	103	U90281A1012	81
RU844HR	72	SW4815080209000	109	TSS-1	98	U90281B2012	81
RU844SS	72	TH4840020010000	107	TSS-2	98	U90281D3017	81
RU853HR	72	TH4845020010000	107	TV24F	47	U90281G10112017	81
RU853SS	72	TL4229040010000	107	TV24R	47	U90281H20121017	81
RU854HR	72	TL42290400SG000	107	TV48F	47	U90281L20112017	81
RU854SS	72	TL4840030010000	107	TV48R	47	U90282A1011	81
RWH24481A5M8	82	TL4844030010000	107	TV5748020010000	107	U90282A1012	81
RWH24481A5M8A	82	TL48440300SG000	107	TV6448020010000	107	U90282B2012	81
RWH2448EA5M6	83	TN4845020010000	107	TV7048020010000	107	U90282D3017	81
RWH2448EA5M6A	83	TS1000B	97	TV70F	47	U90282G10112017	81
RWH30601A5M8	82	TS100A	95	TV70R	47	U90282H20121017	81
RWH30601A5M8A	82	TS101IB	98	TVCLIP	47	U90282L20112017	81
RWH3060EA5M6	83	TS103IB	98	TVHDWR	47	U90284A1011	81
RWH3060EA5M6A	83	TS105A	95	TVLR	47	U90284A1012	81
RWH324481A5M8	82	TS105IB	98	TVLRA	47	U90284B2012	81
RWH324481A5M8A	82	TS108A	95	TVSTACKCART	85	U90284G10112017	81
RWH324481A5Y6	82	TS108JB	101	U90110A1411	81	U90284L20112017	81
RWH324481A5Y6A	82	TS110-20	98	U90110A1412	81	U90285A1011	81
RWH32448EA5M6	83	TS110A	95	U90110B2412	81		
RWH32448EA5M6A	83	TS111ECS	96	U90110G14112817	81		
RWH330601A5M8	82	TS115A	95	U90110L24112817	81		
RWH330601A5M8A	82	TS1200B	97	U90162A1411	81		
RWH330601A5Y6	82	TS125A	95	U90162A1412	81		
RWH330601A5Y6A	82	TS125B	95	U90162D3817	81		
RWH33060EA5M6	83	TS125EC	96	U90162H24121817	81		
RWH33060EA5M6A	83	TS135A	95	U90163A1411	81		
RWHV24481A5M8	82	TS135B	95	U90163A1412	81		
RWHV24481A5M8A	82	TS145A	95	U90163D3817	81		
RWHV24481A5Y6	82	TS145B	95	U90163H24121817	81		
RWHV24481A5Y6A	82	TS155B	95	U90163L24112817	81		
RWHV2448EA5M6	83	TS160B	95	U90165A1411	81		
RWHV2448EA5M6A	83	TS165B	97	U90165A1412	81		
RWHV30601A5M8	82	TS1700B	99	U90181A1411	81		
RWHV30601A5M8A	82	TS1750B	99	U90181A1412	81		
RWHV30601A5Y6	82	TS180B	95, 99	U90181B2412	81		
RWHV30601A5Y6A	82	TS185B	97	U90181D3817	81		
RWHV3060EA5M6	83	TS195B	95	U90181G14112817	81		
RWHV3060EA5M6A	83	TS300E	96	U90181H24121817	81		

Notes

MATERIAL HANDLING : STORAGE : TRANSPORT PRODUCTS



AK-WEST INC

Your Single Source for Reusable Containers and Material Handling Solutions

www.ak-westinc.com



Alberta

Calgary

7111H - 6th Street SE
Calgary, AB
T2H 2M8

Phone: (403) 279-8940
Fax: (403) 225-1696
Toll Free: 1-877-979-8940
www.ak-westinc.com

Ontario

Mississauga

1695 Drew Road, Unit 3
Mississauga, ON
L5S 1J5